



BOR TIL STEN OG BETON



**DIAGER**<sup>®</sup>



# 3-SKÆRS TEKNOLOGI



## Alle produkter med 3-SKÆRS TEKNOLOGI



ARMERET BETON

**booster**  
PLUS

KOMPATIBEL SDS-PLUS



VINDUE OG RAMME BOR

KOMPATIBEL SDS-PLUS



BOR MED STOP

KOMPATIBEL SDS-PLUS





**INGEN  
OVEROPHEDNING**



**HAMMEREFFEKT**

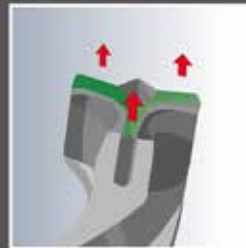

**PRÆCISION**

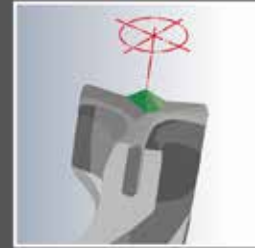

**KONTROL AF  
RETNING**



**PERFEKT  
FORANKRING**



**BEDRE STØV  
TRANSPORT**

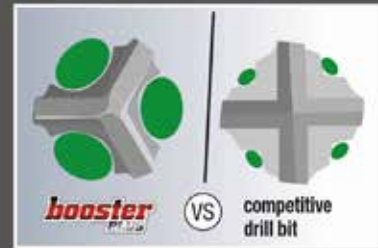

**SPECIAL  
REINFORCED  
CONCRETE**

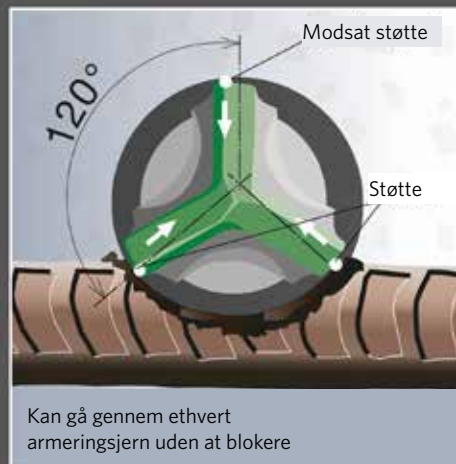

# 3-SKÆRS HAMMERBOR



## hooster PLUS



### SDS-PLUS 3-SKÆRS HAMMERBOR

Den 3-skærs monoblokspids er løsningen til al betonboring. Spidsdesignet garanterer et rundt hul, og den firkantede rille øger støvtransporten og giver en perfekt størrelse huller. Højtydende bor til boring i den hårdeste beton og armeret beton.

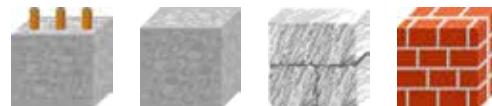

Armeret beton, beton, sten/granit og mursten.

Ref. 113 / BETON

Ø / mm	Spiral L / mm	Total L / mm	Varenr.	Indhold	DKK	Lager
5,0	50	110	113D05L0110	1	71,00	✓
5,0	100	160	113D05L0160	1	71,00	✓
5,5	100	160	113D055L0160	1	75,00	✓
5,5	150	210	113D055L0210	1	95,00	✓
6,0	50	110	113D06L0110	1	65,00	✓
6,0	100	160	113D06L0160	1	69,00	✓
6,0	150	210	113D06L0210	1	83,00	✓
6,0	200	260	113D06L0260	1	89,00	✓
6,0	250	310	113D06L0310	1	100,00	✓
6,5	50	110	113D065L0110	1	78,00	✓
6,5	100	160	113D065L0160	1	78,00	✓
6,5	150	210	113D065L0210	1	83,00	✓
6,5	200	260	113D065L0260	1	98,00	✓
6,5	250	310	113D065L0310	1	100,00	✓
6,5	400	460	113D065L0460	1	213,00	✓
7,0	100	160	113D07L0160	1	80,00	✓
7,0	150	210	113D07L0210	1	86,00	✓
7,0	250	310	113D07L0310	1	115,00	✓
8,0	50	110	113D08L0110	1	78,00	✓
8,0	100	160	113D08L0160	1	82,00	✓
8,0	150	210	113D08L0210	1	84,00	✓
8,0	200	260	113D08L0260	1	97,00	✓
8,0	250	310	113D08L0310	1	115,00	✓
8,0	400	460	113D08L0460	1	237,00	✓
8,0	550	610	113D08L0610	1	423,00	✓
9,0	100	160	113D09L0160	1	98,00	✓
9,0	150	210	113D09L0210	1	102,00	✓
10,0	50	110	113D10L0110	1	88,00	✓
10,0	100	160	113D10L0160	1	96,00	✓
10,0	150	210	113D10L0210	1	94,00	✓
10,0	200	260	113D10L0260	1	107,00	✓



Skaft: SDS-plus

Ø / mm	Spiral L / mm	Total L / mm	Varenr.	Indhold	DKK	Lager
10,0	250	310	113D10L0310	1	141,00	✓
10,0	400	460	113D10L0460	1	240,00	✓
10,0	550	610	113D10L0610	1	403,00	✓
12,0	100	160	113D12L0160	1	91,00	✓
12,0	150	210	113D12L0210	1	95,00	✓
12,0	200	260	113D12L0260	1	123,00	✓
12,0	250	310	113D12L0310	1	161,00	✓
12,0	400	460	113D12L0460	1	353,00	✓
12,0	550	610	113D12L0610	1	415,00	✓
13,0	100	160	113D13L0160	1	124,00	✓
14,0	100	160	113D14L0160	1	118,00	✓
14,0	150	210	113D14L0210	1	132,00	✓
14,0	200	260	113D14L0260	1	160,00	✓
14,0	250	310	113D14L0310	1	189,00	✓
14,0	400	460	113D14L0460	1	273,00	✓
14,0	550	610	113D14L0610	1	355,00	✓
15,0	100	160	113D15L0160	1	152,00	✓
15,0	150	210	113D15L0210	1	175,00	✓
15,0	250	310	113D15L0310	1	184,00	✓
16,0	100	160	113D16L0160	1	163,00	✓
16,0	150	210	113D16L0210	1	185,00	✓
16,0	200	260	113D16L0260	1	168,00	✓
16,0	250	310	113D16L0310	1	193,00	✓
16,0	400	460	113D16L0460	1	310,00	✓
16,0	550	610	113D16L0610	1	449,00	✓
18,0	150	210	113D18L0210	1	259,00	✓
18,0	200	260	113D18L0260	1	232,00	✓
18,0	250	310	113D18L0310	1	281,00	✓
18,0	400	460	113D18L0460	1	380,00	✓
18,0	550	610	113D18L0610	1	670,00	✓
20,0	150	210	113D20L0210	1	347,00	✓
20,0	200	260	113D20L0260	1	359,00	✓
20,0	250	310	113D20L0310	1	376,00	✓
20,0	400	460	113D20L0460	1	436,00	✓
20,0	550	610	113D20L0610	1	708,00	✓





# 3-SKÆRS HAMMERBOR



## Pakke med 12 stk.

Ref. 157L / BETON

Ø / mm	Spiral L / mm	Total L / mm	Varenr.	Indhold	DKK	Lager
5,0	100	160	157LD05L0160	12 stk.	678,00	✓
6,0	100	160	157LD06L0160	12 stk.	624,00	✓
6,0	150	210	157LD06L0210	12 stk.	790,00	✓
6,0	200	260	157LD06L0260	12 stk.	856,00	✓
6,5	100	160	157LD065L0160	12 stk.	708,00	✓
6,5	150	210	157LD065L0210	12 stk.	790,00	✓
8,0	100	160	157LD08L0160	12 stk.	771,00	✓
8,0	150	210	157LD08L0210	12 stk.	807,00	✓
8,0	200	260	157LD08L0260	12 stk.	830,00	✓
8,0	250	310	157LD08L0310	12 stk.	1.051,00	✓
10,0	100	160	157LD10L0160	12 stk.	824,00	✓
10,0	150	210	157LD10L0210	12 stk.	901,00	✓
10,0	200	260	157LD10L0260	12 stk.	971,00	✓
10,0	250	310	157LD10L0310	12 stk.	1.225,00	✓
12,0	100	160	157LD12L0160	12 stk.	927,00	✓
12,0	150	210	157LD12L0210	12 stk.	1.022,00	✓
12,0	200	260	157LD12L0260	12 stk.	1.089,00	✓
12,0	250	310	157LD12L0310	12 stk.	1.383,00	✓
14,0	200	260	157LD14L0260	12 stk.	1.344,00	✓
16,0	100	160	157KD16L0160	6 stk.*	784,00	✓
16,0	200	260	157LD16L0260	12 stk.	1.570,00	✓

\* OBS! Pakke med 6 stk.



Skaft: SDS-plus

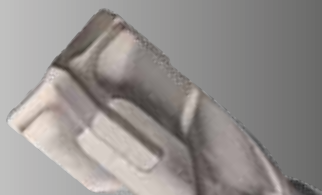

## Hammerbor med dybdestop



### SDS-PLUS 3-SKÆRS HAMMERBOR MED DYBDESTOP

Dette bor er sammensat af et stop, der gør det muligt at kontrollere boreddybden. Ideel til serieboring af huller af nøjagtig samme dybde i den hårdeste beton og armeret beton. Hovedets geometri sikrer et perfekt rundt og ensartet hul.

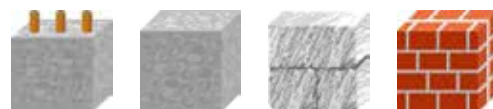

Armeret beton, beton, sten/granit og mursten.

Ref. 108 / BETON

Ø / mm	Spiral L / mm	Total L / mm	Varenr.	Indhold	DKK	Lager
8,0	27	110	108D08L0027	1	178,00	-
10,0	33	110	108D10L0033	1	200,00	-
12,0	43	130	108D12L0043	1	219,00	-
15,0	52	160	108D15L0052	1	281,00	-
15,0	54	160	108D15L0054	1	281,00	-



Skaft: SDS-plus

# 4-SKÆRS HAMMERBOR

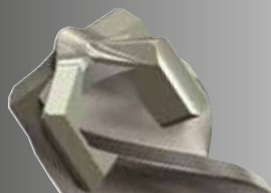

## SDS-PLUS 4-SKÆRS HAMMERBOR

Det 4-skærs hårdmetalborehoved og de 4 spiralformede riller sikrer cirkulære borehuller og sikrer et rundt hul.

Er lavet af legeret stål af høj kvalitet og et hårdmetalskær, der garanterer stor ydeevne og holdbarhed i selv den hårdeste beton.

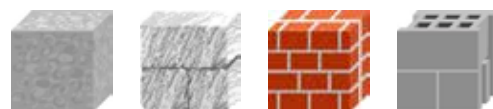

Beton, sten/granit, mursten og hule blokke.

Ref. 112 / BETON

Ø / mm	Spiral L / mm	Total L / mm	Varenr.	Indhold	DKK	Lager
5,0	50	110	112D05L0110	1	51,00	✓
5,5	50	110	112D055L0110	1	57,00	✓
5,5	100	160	112D055L0160	1	63,00	✓
6,0	50	110	112D06L0110	1	52,00	✓
6,0	100	160	112D06L0160	1	56,00	✓
6,0	150	210	112D06L0210	1	60,00	✓
6,0	200	260	112D06L0260	1	94,00	✓
6,0	250	310	112D06L0310	1	127,00	✓
6,5	50	110	112D065L0110	1	59,00	✓
6,5	100	160	112D065L0160	1	60,00	✓
6,5	150	210	112D065L0210	1	98,00	✓
6,5	250	310	112D065L0310	1	147,00	✓
8,0	50	110	112D08L0110	1	63,00	✓
8,0	100	160	112D08L0160	1	64,00	✓
8,0	150	210	112D08L0210	1	69,00	✓
8,0	200	260	112D08L0260	1	82,00	✓
8,0	250	310	112D08L0310	1	117,00	✓
8,0	400	460	112D08L0460	1	262,00	✓
10,0	100	160	112D10L0160	1	70,00	✓
10,0	150	210	112D10L0210	1	78,00	✓
10,0	200	260	112D10L0260	1	90,00	✓
10,0	250	310	112D10L0310	1	119,00	✓
10,0	400	460	112D10L0460	1	229,00	✓
12,0	100	160	112D12L0160	1	79,00	✓
12,0	150	210	112D12L0210	1	96,00	✓
12,0	200	260	112D12L0260	1	108,00	✓
12,0	250	310	112D12L0310	1	156,00	✓
12,0	400	460	112D12L0460	1	246,00	✓
13,0	100	160	112D13L0160	1	104,00	✓
14,0	100	160	112D14L0160	1	125,00	✓
14,0	150	210	112D14L0210	1	147,00	✓



Skaft: SDS-plus



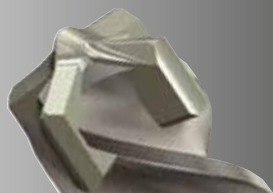

**Ref. 112 / BETON**

Ø / mm	Spiral L / mm	Total L / mm	Varenr.	Indhold	DKK	Lager
14,0	250	310	112D14L0310	1	189,00	✓
14,0	400	460	112D14L0460	1	246,00	✓
15,0	100	160	112D15L0160	1	148,00	✓
15,0	150	210	112D15L0210	1	170,00	✓
16,0	100	160	112D16L0160	1	153,00	✓
16,0	150	210	112D16L0210	1	189,00	✓
16,0	250	310	112D16L0310	1	246,00	✓
16,0	400	460	112D16L0460	1	287,00	✓
18,0	250	310	112D18L0310	1	278,00	✓
18,0	400	460	112D18L0460	1	422,00	✓
20,0	250	310	112D20L0310	1	364,00	✓
20,0	400	460	112D20L0460	1	435,00	✓
22,0	200	260	112D22L0260	1	469,00	✓
22,0	400	460	112D22L0460	1	655,00	✓
24,0	200	260	112D24L0260	1	598,00	✓
24,0	400	460	112D24L0460	1	850,00	✓
25,0	200	260	112D25L0260	1	637,00	✓
25,0	400	460	112D25L0460	1	985,00	✓
26,0	200	260	112D26L0260	1	684,00	✓
26,0	400	460	112D26L0460	1	1.134,00	✓
28,0	400	460	112D28L0460	1	1.642,00	✓
30,0	400	460	112D30L0460	1	1.992,00	✓
32,0	400	460	112D32L0460	1	2.191,00	✓



Skaft: SDS-plus

# 2-SKÆRS HAMMERBOR



**twister<sup>2</sup>**  
plus



## SDS-PLUS 2-SKÆRS HAMMERBOR

Speciel hårdmetalspidsprofil kombineret med 3-ZONE helix reducerer boretiden, begrænser slid og forlænger borets levetid.

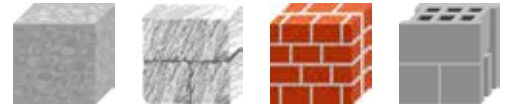

Beton, sten/granit, mursten og hule blokke.

Ref. 110 / BETON

Ø / mm	Spiral L / mm	Total L / mm	Varenr.	Indhold	DKK	Lager
4,0	100	160	110D04L0160	1	53,00	✓
5,0	100	160	110D05L0160	1	46,00	✓
5,0	150	210	110D05L0210	1	64,00	✓
5,0	250	310	110D05L0310	1	104,00	✓
5,5	100	160	110D055L0160	1	47,00	✓
5,5	200	260	110D055L0260	1	125,00	✓
5,5	250	310	110D055L0310	1	142,00	✓
6,0	100	160	110D06L0160	1	36,00	✓
6,0	200	260	110D06L0260	1	96,00	✓
6,0	250	310	110D06L0310	1	119,00	✓
6,5	100	160	110D065L0160	1	47,00	✓
6,5	150	210	110D065L0210	1	62,00	✓
6,5	200	260	110D065L0260	1	100,00	✓
7,0	100	160	110D07L0160	1	48,00	✓
8,0	100	160	110D08L0160	1	40,00	✓
8,0	150	210	110D08L0210	1	52,00	✓
8,0	200	260	110D08L0260	1	76,00	✓
8,0	250	310	110D08L0310	1	102,00	✓
8,0	940	1000	110D08L1000	1	798,00	✓
9,0	100	160	110D09L0160	1	57,00	✓
10,0	100	160	110D10L0160	1	51,00	✓
10,0	150	210	110D10L0210	1	66,00	✓
10,0	200	260	110D10L0260	1	79,00	✓
10,0	250	310	110D10L0310	1	107,00	✓
10,0	940	1000	110D10L1000	1	798,00	✓
12,0	100	160	110D12L0160	1	58,00	✓
12,0	150	210	110D12L0210	1	82,00	✓
12,0	200	260	110D12L0260	1	102,00	✓
12,0	250	310	110D12L0310	1	134,00	✓
12,0	940	1000	110D12L1000	1	798,00	✓



Skaft: SDS-plus



Ref. 110 / BETON

Ø / mm	Spiral L / mm	Total L / mm	Varenr.	Indhold	DKK	Lager
14,0	100	160	110D14L0160	1	94,00	✓
14,0	150	210	110D14L0210	1	106,00	✓
14,0	250	310	110D14L0310	1	152,00	✓
14,0	940	1000	110D14L1000	1	842,00	✓
16,0	100	160	110D16L0160	1	131,00	✓
16,0	150	210	110D16L0210	1	126,00	✓
16,0	250	310	110D16L0310	1	166,00	✓
16,0	940	1000	110D16L1000	1	852,00	✓
18,0	150	210	110D18L0210	1	177,00	✓
18,0	200	260	110D18L0260	1	192,00	✓
18,0	250	310	110D18L0310	1	240,00	✓
18,0	940	1000	110D18L1000	1	1.013,00	✓
20,0	150	210	110D20L0210	1	236,00	✓
20,0	200	260	110D20L0260	1	292,00	✓
20,0	250	310	110D20L0310	1	322,00	✓
20,0	940	1000	110D20L1000	1	1.260,00	✓
22,0	150	210	110D22L0210	1	326,00	✓
22,0	200	260	110D22L0260	1	358,00	✓
22,0	250	310	110D22L0310	1	405,00	✓
22,0	940	1000	110D22L1000	1	1.417,00	✓
25,0	940	1000	110D25L1000	1	1.554,00	✓



Skaft: SDS-plus



# NYT 3-ZONE BOR

③

**BORTLEDNING**

②

**ACCELERATION  
AF STØV**

①

**KNUSNING**

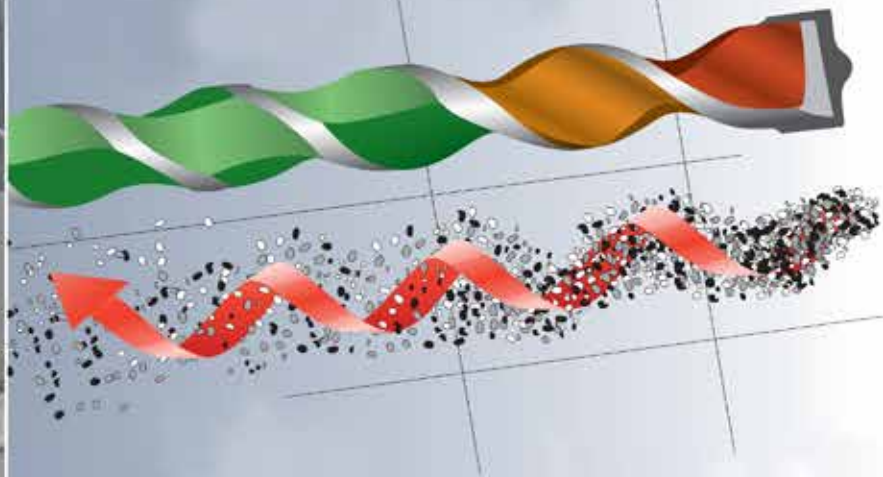

## NY HM-PLATTE

**3 STØD PUNKTER**  
Forhøjer slagkraften  
og forbedrer  
borehastigheden

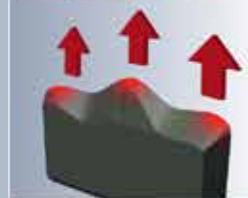

**Z-DESIGN SPIDS**  
Øger aggressiviteten  
og forstærker  
mejslinge-effekten



# 2-SKÆRS HAMMERBOR



**DIAGER**

## WALLSTER



### SDS-PLUS 2-SKÆRS HAMMERBOR

Specielt designet til at bore gennem hule mursten og hule blokke uden at beskadige karmen. Giver mulighed for at lave kvalitetshuller, hvorskruen sidder bedre fast. Den reducerede slageffekt giver microslag og sikrer, at hulstenens vægge ikke knækker.



Hule blokke og hule mursten.

Ref. 104 / BETON

Ø / mm	Spiral L / mm	Total L / mm	Varenr.	Indhold	DKK	Lager
6,0	200	260	104D06L0260	1	115,00	✓
8,0	200	260	104D08L0260	1	119,00	✓
10,0	200	260	104D10L0260	1	129,00	✓
12,0	200	260	104D12L0260	1	155,00	✓
14,0	200	260	104D14L0260	1	192,00	✓
16,0	200	260	104D16L0260	1	205,00	✓



Skaft: SDS-plus





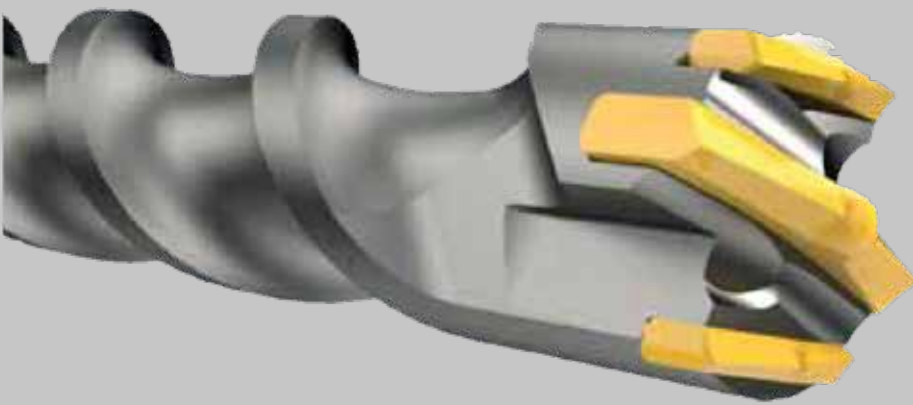

## KOMFORT

- Antiblokeringsystem
- Nedsætter vibrationer

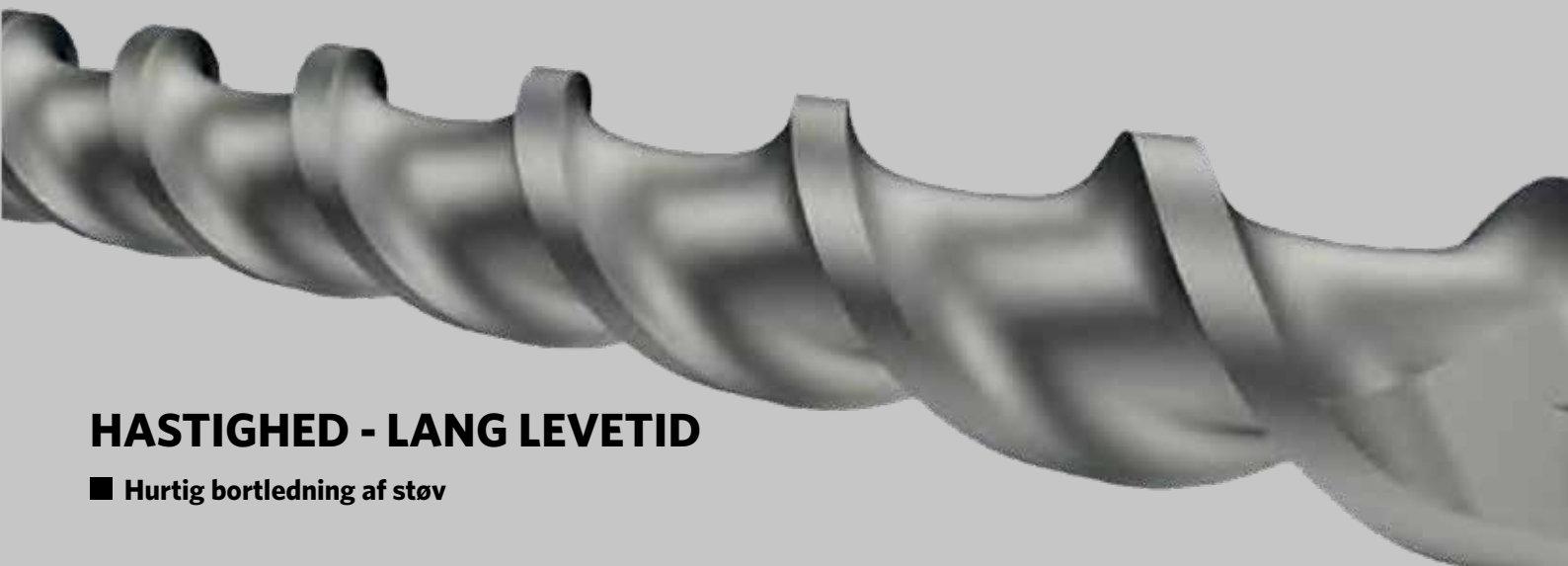

## HASTIGHED - LANG LEVETID

- Hurtig bortledning af støv



# 6-SKÆRS HAMMERBOR





## ULTIMAX

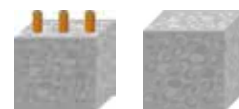

### SDS-MAX 6-SKÆRS HAMMERBOR

SDS Max hammerbor med højtydende 6 skær til boring i hård og armeret beton. Bruges til at lave runde huller i forskellige typer materialer.



Armeret beton og beton

Ref. 168 / BETON

Ø / mm	Spiral L / mm	Total L / mm	Varenr.	Indhold	DKK	Lager
12,0	200	340	168D12L0340	1	342,00	✓
12,0	400	540	168D12L0540	1	397,00	✓
14,0	200	340	168D14L0340	1	410,00	✓
14,0	400	540	168D14L0540	1	470,00	✓
15,0	200	340	168D15L0340	1	458,00	✓
16,0	200	340	168D16L0340	1	455,00	✓
16,0	400	540	168D16L0540	1	528,00	✓
16,0	550	690	168D16L0690	1	678,00	✓
16,0	780	920	168D16L0920	1	709,00	✓
18,0	200	340	168D18L0340	1	488,00	✓
18,0	400	540	168D18L0540	1	541,00	✓
18,0	550	690	168D18L0690	1	678,00	✓
18,0	780	920	168D18L0920	1	800,00	✓
20,0	200	340	168D20L0340	1	523,00	✓
20,0	400	540	168D20L0540	1	602,00	✓
20,0	550	690	168D20L0690	1	719,00	✓
20,0	780	920	168D20L0920	1	821,00	✓
20,0	1160	1300	168D20L1300	1	1.307,00	✓
20,0	1360	1500	168D20L1500	1	1.525,00	✓



Skaft: SDS-max

# 6-SKÆRS HAMMERBOR



Ref. 168 / BETON

Ø / mm	Spiral L / mm	Total L / mm	Varenr.	Indhold	DKK	Lager
22,0	200	340	168D22L0340	1	538,00	✓
22,0	400	540	168D22L0540	1	629,00	✓
22,0	550	690	168D22L0690	1	741,00	✓
22,0	780	920	168D22L0920	1	876,00	✓
22,0	1160	1300	168D22L1300	1	1.633,00	✓
22,0	1360	1500	168D22L1500	1	2.088,00	✓
24,0	200	340	168D24L0340	1	550,00	✓
24,0	400	540	168D24L0540	1	689,00	✓
24,0	550	690	168D24L0690	1	853,00	✓
24,0	780	920	168D24L0920	1	1.003,00	✓
24,0	1360	1500	168D24L1500	1	1.915,00	✓
25,0	200	340	168D25L0340	1	569,00	✓
25,0	400	540	168D25L0540	1	702,00	✓
25,0	550	690	168D25L0690	1	869,00	✓
25,0	780	920	168D25L0920	1	1.003,00	✓
25,0	1360	1500	168D25L1500	1	2.196,00	✓
26,0	200	340	168D26L0340	1	606,00	✓
26,0	400	540	168D26L0540	1	750,00	✓
26,0	550	690	168D26L0690	1	942,00	✓
26,0	780	920	168D26L0920	1	1.240,00	✓
28,0	200	340	168D28L0340	1	671,00	✓
28,0	400	540	168D28L0540	1	757,00	✓
28,0	550	690	168D28L0690	1	928,00	✓
28,0	780	920	168D28L0920	1	1.278,00	✓
28,0	1160	1300	168D28L1300	1	1.988,00	✓
28,0	1360	1500	168D28L1500	1	2.346,00	✓
30,0	200	340	168D30L0340	1	738,00	✓
30,0	400	540	168D30L0540	1	843,00	✓
30,0	550	690	168D30L0690	1	1.052,00	✓
30,0	780	920	168D30L0920	1	1.323,00	✓
32,0	200	340	168D32L0340	1	855,00	✓
32,0	400	540	168D32L0540	1	907,00	✓
32,0	550	690	168D32L0690	1	1.052,00	✓
32,0	780	920	168D32L0920	1	1.350,00	✓
32,0	1160	1300	168D32L1300	1	2.059,00	✓
32,0	1360	1500	168D32L1500	1	2.698,00	✓



Skaft: SDS-max



**DIAGER®****Ref. 168 / BETON**

Ø / mm	Spiral L / mm	Total L / mm	Varenr.	Indhold	DKK	Lager
35,0	200	340	168D35L0340	1	856,00	✓
35,0	400	540	168D35L0540	1	1.025,00	✓
35,0	550	690	168D35L0690	1	1.218,00	✓
35,0	780	920	168D35L0920	1	1.730,00	✓
35,0	1160	1300	168D35L1300	1	2.059,00	✓
36,0	400	540	168D36L0540	1	1.111,00	✓
36,0	550	690	168D36L0690	1	1.234,00	✓
36,0	780	920	168D36L0920	1	1.762,00	✓
38,0	400	540	168D38L0540	1	1.605,00	✓
38,0	550	690	168D38L0690	1	1.903,00	✓
40,0	400	540	168D40L0540	1	1.669,00	✓
40,0	550	690	168D40L0690	1	2.141,00	✓
40,0	780	920	168D40L0920	1	2.269,00	✓
40,0	1360	1500	168D40L1500	1	3.766,00	✓
42,0	400	540	168D42L0540	1	2.013,00	✓
42,0	550	690	168D42L0690	1	2.031,00	✓
42,0	780	920	168D42L0920	1	2.494,00	✓
45,0	200	340	168D45L0340	1	1.641,00	✓
45,0	400	540	168D45L0540	1	2.062,00	✓
45,0	550	690	168D45L0690	1	2.300,00	✓
45,0	780	920	168D45L0920	1	2.905,00	✓
45,0	1360	1500	168D45L1500	1	5.396,00	✓
52,0	400	540	168D52L0540	1	2.686,00	✓



Skaft: SDS-max



STØVFRI BORING

**SPEEDUSTER 646**



## STØVFRI OPGAVER

SPEEDUSTER støvfri bor med det massive hoved gør det muligt at fjerne støv med det samme. SPEEDUSTER borer hurtigere og uden blokering, og levetiden er betydelig længere.



### RENERE ARBEJDSPLADS



SPEEDUSTER borer og afleder støv på én gang, så arbejdet går hurtigere. Interiør bliver fri for støv og holder længere.

### BESKYTTELSE



I henhold til de nye internationale regler for støvgrænseværdier bliver brugeren beskyttet for farligt støv.

### HURTIG BORING

BORER DOBBELT SÅ HURTIGT

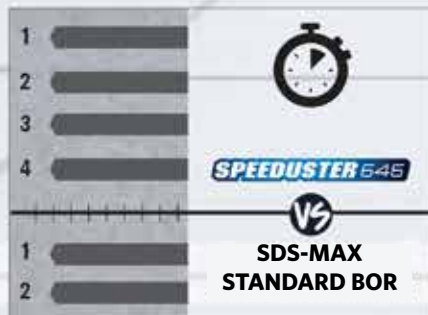

SPEEDUSTER borer 4 huller vs. 2 sammenlignelige SDS-Max bor

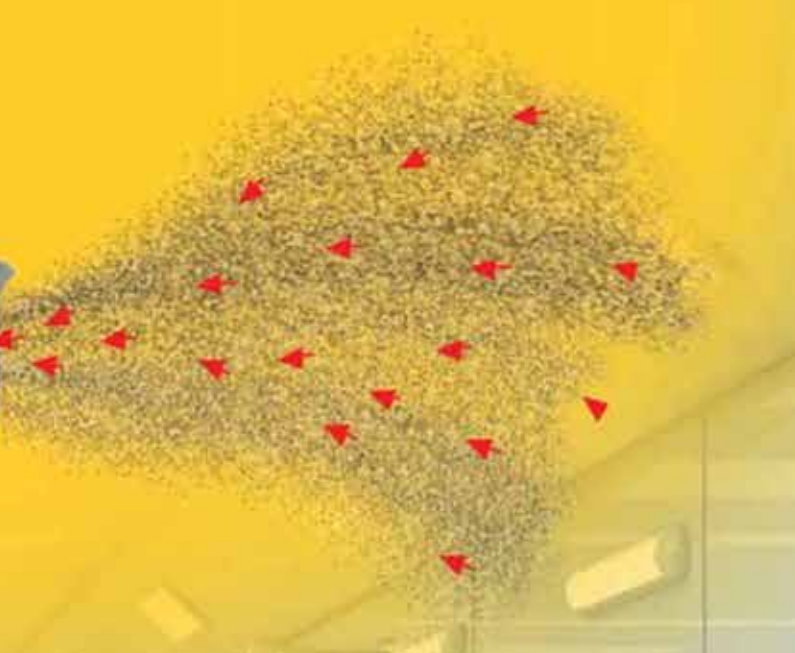

**ny**

**SDS-plus**

**BOR SAMMENLIGNING**

**SDS-MAX  
STANDARD BOR**



**SPEEDUSTER 646**



**1 KG STØV**



**STØVFRI**



Bor diameter 32 mm, længde 1 m, dybde i C50/60 beton



**EFFEKTIV**

**FASTGØRES I KUN 2 TRIN**

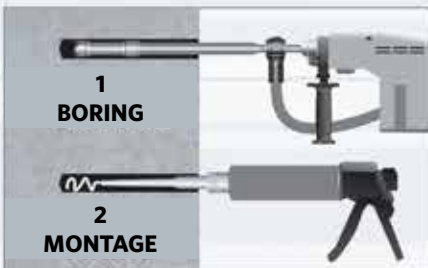

Huller bores og renses i én arbejdsgang. Kemisk fastgørelse bliver 10 så stærk pga. de helt rene huller.

# 3-SKÆRS SUGEBOR

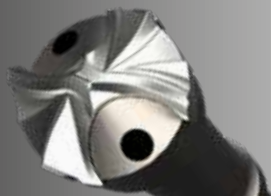

## SPEEDUSTER



### SDS-PLUS SUGEBOR

Boring og støvfjernelse i én proces. Speeduster sugeboret muliggør øjeblikkelig og total støvfjernelse. Den borer derfor hurtigere, og borets levetid forlænges betydeligt. Boret har to store huller til støvudsugning og manchetter til fastgørelse af støvsugerrør.



Armeret beton, beton, granit, sten og mursten.

Ref. 114 / BETON

Ø / mm	Spiral L / mm	Total L / mm	Varenr.	Indhold	DKK	Lager
12,00	265	410	114D12L0410	1	1.095,00	✓
14,00	265	410	114D14L0410	1	1.103,00	✓
16,00	265	410	114D16L0410	1	1.109,00	✓
18,00	265	410	114D18L0410	1	1.126,00	✓
20,00	265	410	114D20L0410	1	1.211,00	✓

BØSNING KOMPATIBEL MED STØVSUGERSLANGE Ø 35 TIL 40MM



Skaft: SDS-plus



# 3-SKÆRS SUGEBOR

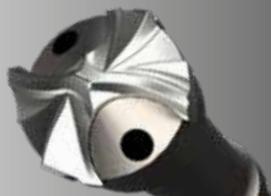

**DIAGER**

## SPEEDUSTER 646



### SDS-MAX SUGEBOR

Boring og støvfjernelse i én proces. Speeduster 646 sugeboret muliggør øjeblikkelig og total støvfjernelse. Den borer derfor hurtigere, og borets levetid forlænges betydeligt. Boret har to store huller til støvudsugning og manchetter til fastgørelse af støvsugerrør.



Armeret beton, beton, granit, sten og mursten.

### 3-skærs

Ref. 161 / BETON

Ø / mm	Spiral L / mm	Total L / mm	Varenr.	Indhold	DKK	Lager
14,0	400	610	161D14L0610	1	1.622,00	✓
16,0	400	610	161D16L0610	1	1.690,00	✓
18,0	400	610	161D18L0610	1	1.755,00	✓
20,0	400	610	161D20L0610	1	1.820,00	✓

### 10-skærs

Ø / mm	Spiral L / mm	Total L / mm	Varenr.	Indhold	DKK	Lager
22,0	400	610	161D22L0610	1	1.949,00	✓
25,0	400	610	161D25L0610	1	2.078,00	✓
28,0	400	610	161D28L0610	1	2.338,00	✓
30,0	400	610	161D30L0610	1	2.402,00	✓
32,0	400	610	161D32L0610	1	2.597,00	✓
35,0	400	610	161D35L0610	1	2.726,00	✓

### TILBEHØR TIL SUGEBOR

Sæt bestående af en muffe og en O-ring til SDS-max sugebor.



Ref. 161DM / BETON

Varenr.	Indhold	DKK	Lager
161DMAX	1	211,00	✓



Skaft: SDS-max



**1** SDS-MAX adapter



**2** Borforlænger



## Råd

- Afslut spændingen af værktøjerne med en flad skruenøgle
- Smør jævnligt koblings-skrue og gevindboringerne
- Leveres med fjeder til indføring i hun-delen (låsesystem)







**2** Borforlænger



**3** Spiral



**4** Borehoved med centrerbør



# DET MODULOPBYGGEDE POWER MAX SYSTEM

Justerbart og opgraderbart system til dybdeboring op til 1,7 m.

Passer til alle borehammere kun ved at udskifte adapteren.

Kapacitet til at tilpasse hovedet fra Ø 32 til 80 mm. Hoved med hårdmetalspids og centrerbør med 2 skærekanter.

- **Alsidig og modulopbygget**
  - **Stor diameter**
  - **Dybdeboring op til 1,7 m**



## DET MODULOPBYGGEDE SYSTEM

### SDS-MAX POWER MAX BOREHOVED

Power Max 4-skærs hoved med hårdmetalspids og centrerende bor, der tillader boring til dybder på mere end 1 m. Til alle boresituationer og specielt tilpasset til boring af store længder.



Beton, sten/granit og hule blokke.

Ref. 373B / BETON

Ø / mm	L / mm	Varenr.	Indhold	DKK	Lager
32,0	43	373BD32	1	1.734,00	-
44,0	43	373BD44	1	1.901,00	-
52,0	43	373BD52	1	2.148,00	-
60,0	43	373BD60	1	2.519,00	-
66,0	43	373BD66	1	2.908,00	-
80,0	43	373BD80	1	3.439,00	-

- Det modulopbyggede system tillader boring til dybder på mere end 1 m.
- Mulighed for montering af borehoveder Ø 32 til 80 mm eller hårdmetal bor Ø 30 til 125 mm.



### SDS-MAX POWER MAX SPIRAL

Specielt tilpasset til Power Max hoved 44 til 52 mm og 60 til 80 mm. Til alle boresituationer og specielt tilpasset til boring af store længder.



Ref. 372B / BETON

Hoved Ø / mm	Ø / mm	L / mm	Varenr.	Indhold	DKK	Lager
44-52	40	180	372BD40	1	1.426,00	-
60-80	55	90	372BD55	1	2.599,00	-

- Det modulopbyggede system tillader boring til dybder på mere end 1 m.
- Mulighed for montering af borehoveder Ø 32 til 80 mm eller hårdmetal bor Ø 30 til 125 mm.



Skaft: SDS-max





### SDS-MAX POWER MAX FORLÆNGER M/SKRUE

Power max forlænger på 280 mm inkl. koblingsskrue og fjeder.  
Til alle boresituationer og specielt tilpasset til boring af store dybder.



Ref. 371B / BETON

Ø / mm	L / mm	Varenr.	Indhold	DKK	Lager
14	280	371BD0280	1	1.167,00	-

- Det modulopbyggede system tillader boring til dybder på mere end 1 m.
- Mulighed for montering af borehoveder Ø 32 til 80 mm eller hårdmetal bor Ø 30 til 125 mm.



### SDS-MAX POWER MAX ADAPTER

Længde 250 mm, 450 mm eller 850 mm.



Ref. 370B / BETON

Ø / mm	L / mm	Varenr.	Indhold	DKK	Lager
14	250	370BD0250	1	932,00	-
14	450	370BD0450	1	1.605,00	-
14	850	370BD0850	1	2.890,00	-



### SDS-MAX CENTRERINGSBOR TIL POWER MAX HOVED

Udskiftningsbor, der kan tilpasses alle Power-Max-hoveder.



Ref. 374B / BETON

Ø / mm	L / mm	Varenr.	Indhold	DKK	Lager
12	50	374B	1	330,00	-

- Det modulopbyggede system tillader boring til dybder på mere end 1 m.
- Mulighed for montering af borehoveder Ø 32 til 80 mm eller hårdmetal bor Ø 30 til 125 mm.



Skaft: SDS-max



# POWER MAX

## SDS-MAX POWER MAX KOBLINGSSKRUE + FJEDER

Kan samle Power Max hoved, spiral og forlængere.



Ref. 375B / BETON

Ø / mm	L / mm	Varenr.	Indhold	DKK	Lager
14	62	375B	1	161,00	-

- Det modulopbyggede system tillader boring til dybder på mere end 1 m.
- Mulighed for montering af borehoveder Ø 32 til 80 mm eller hårdmetal bor Ø 30 til 125 mm.



## SDS-MAX POWER MAX ADAPTER TIL KERNEBIT

For at tilpasse kernebit på Power Max-systemet.



Ref. 376B / BETON

Ø / mm	L / mm	Varenr.	Indhold	DKK	Lager
26	90	376B	1	917,00	-

- Det modulopbyggede system tillader boring til dybder på mere end 1 m.
- Mulighed for montering af borehoveder Ø 32 til 80 mm eller hårdmetal bor Ø 30 til 125 mm.



## SDS-MAX POWER MAX BETONBORESÆT MED 2 FORLÆNGERE

Klar-til-brug-sæt specielt tilpasset til Power-Max-modulsystemet, der tillader dybdeboring. 2 hoveder Ø 32 og 44 mm.

Ref. 093C / BETON

Ø / mm	L / mm	Varenr.	Indhold	DKK	Lager
32-44	910/1000	093C	1	7.583,00	-

Ø 32 x 910 mm

Ø 44 x 1000 mm

Ø 32 x 910 mm

Ø 44 x 1000 mm



Skaft: SDS-max



### SDS-MAX POWER MAX BETONBORESÆT MED 2 FORLÆNGERE

Klar-til-brug-sæt specielt tilpasset til Power-Max-modulsystemet, der tillader dybdeboring. 2 hoveder Ø 44 og 52 mm.

Ref. 090C / BETON	Ø / mm	L / mm	Varenr.	Indhold	DKK	Lager
		44-52	1000	090C	1	7.954,00

	Ø 44 x 1000 mm	
	Ø 52 x 1000 mm	

### SDS-MAX POWER MAX BETONBORESÆT MED 2 FORLÆNGERE

Klar-til-brug-sæt specielt tilpasset til Power-Max-modulsystemet, der tillader dybdeboring. 2 hoveder Ø 52 og 66 mm.

Ref. 091C / BETON	Ø / mm	L / mm	Varenr.	Indhold	DKK	Lager
		52-66	910/1000	091C	1	9.900,00

	Ø 52 x 910 mm	
	Ø 66 x 1000 mm	

### SDS-MAX POWER MAX BETONBORESÆT MED 2 FORLÆNGERE

Klar-til-brug-sæt specielt tilpasset til Power-Max-modulsystemet, der tillader dybdeboring. 2 hoveder Ø 52 og 80 mm.

Ref. 092C / BETON	Ø / mm	L / mm	Varenr.	Indhold	DKK	Lager
		52-80	910/1000	092C	1	10.313,00

	Ø 52 x 910 mm	
	Ø 80 x 1000 mm	



# BETONBOR



## SDS MAX MULTISKÆRENDE BETONBOR

Multiskærende centrerbør med hårdmetalskær. 4 hårdmetalskær i midten. 6 hårdmetalskær i periferien. Dyb- eller gennemboring fra 45 mm til 80 mm i diameter. Velegnet til gennemføring af kabler, rør og rør ved renovering eller nybyggeri.



Beton, sten/granit og mursten.

Ref. 165 / BETON

Antal skær	Ø / mm	Spiral L / mm	Total L / mm	Varenr.	Indhold	DKK	Lager
4	45	450	590	165D45L0590	1	4.172,00	-
4	45	780	990	165D45L0990	1	4.684,00	-
6	55	450	590	165D55L0590	1	4.535,00	-
6	65	450	590	165D65L0590	1	4.974,00	-
6	55	780	990	165D55L0990	1	5.063,00	-
6	65	780	990	165D65L0990	1	5.437,00	-
10	80	450	590	165D80L0590	1	5.437,00	-
10	80	780	990	165D80L0990	1	5.814,00	-

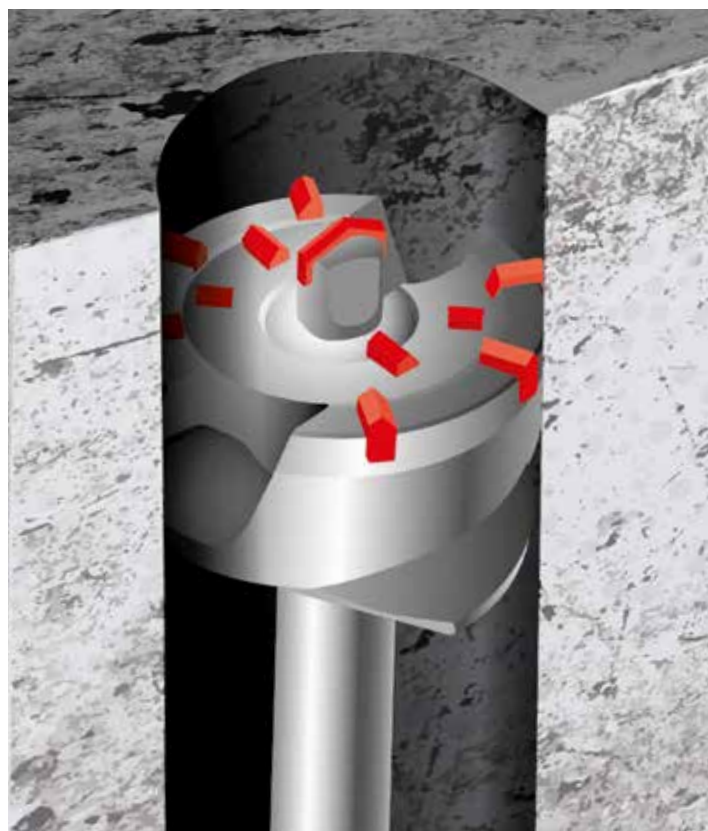

Skaft: SDS-max





### SDS-PLUS ADAPTER

Adapter, der giver dig mulighed for at montere SDS-Plus bor i din SDS-max maskine. Adapterlængde 260 mm.

Ref. 138B / BETON

Varenr.	Indhold	DKK	Lager
138B	1	1.282,00	✓

### BOREPATRON TIL VINKELSLIBER

Nøglefri borepatron med M14 gevind - specielt til vinkelsliber. Spændeevne fra Ø 1,5 til 13 mm.



Ref. 124K / BETON

Varenr.	Indhold	DKK	Lager
124K	1	697,00	✓



Skaft: SDS-max

# SDS-PLUS & SDS-MAX



4-SKÆRS  
ANTIBLOKADE

HÉLICÖIDAL  
PROFIL

## ARBEJDE UDEN BESÆR

Skrueformet punkt, der letter sprængning af materialer, undgår blokeringer og giver bedre ydeevne.

## ANTIBLOKADE

Antiblokeringsgeometrien fremmer sprængning af materialet.

## 100% SLAGKRAFT

Destruktion af betonplader, trin, stenblokke. Gendanner 100 % slagkraft til hammerbor.





# SKRUEFORMEDE MEJSLER

DIAGER®

## SDS-PLUS SKRUEFORMET SPIDSMEJSEL

Mejsel med spiralspids, som letter nedbrydningen af materialer, undgår blokeringer og giver en bedre effektivitet.



Ref. 322 / BETON

Ø / mm	L / mm	Varenr.	Indhold	DKK	Lager
14	250	322D14L0250	1	131,00	✓

## SDS-MAX SKRUEFORMET SPIDSMEJSEL

Mejsel med spiralspids, som letter nedbrydningen af materialer, undgår blokeringer og giver en bedre effektivitet.



Ref. 342 / BETON

Ø / mm	L / mm	Varenr.	Indhold	DKK	Lager
18	400	342D18L0400	1	203,00	✓
18	600	342D18L0600	1	276,00	✓





# DIAMANT- BOREMASKINE



Skaft:  
Kombi 1/2" hun  
+ 1-1/4"han

Ref. 350H / BETON	2.000 W	MAX. Ø 150 MM / BETON
	Optagen effekt (Watt)	2.000
	Max. Ø i beton (mm)	150
	Max. Ø i byggematerialer (mm)	200
	Omdrejningstal (3 hastigheder)	450/1050/2000 o/min.
	Tilslutning (hun)	1/2"
	Tilslutning (han)	1 1/4"
	Indikation af elektrisk overbelastning	✓
	Vægt (kg)	6,5
	Varenr.	350H
DKK	19.734,00	
Lager	✓	



Skaft:  
1-1/4"han

Ref. 351H / BETON	2.500 W	MAX. Ø 250 MM / BETON
	Optagen effekt (Watt)	2.500
	Max. Ø i beton (mm)	250
	Omdrejningstal (3 hastigheder)	200/400/950 o/min.
	Tilslutning (han)	1-1/4"
	Indikation af elektrisk overbelastning	✓
	Vægt (kg)	11,5
	Varenr.	351H
	DKK	28.409,00
	Lager	-



# DIAMANT- BOREMASKINE

DIAGER®



Skaft:  
1-1/4"han

Ref. 356H / BETON

**3.400 W**

**MAX. Ø 375 MM / BETON**

Optagen effekt (Watt)	3.400
Max. Ø i beton (mm)	350
Omdrejningstal (3 hastigheder)	230/520/965 o/min.
Tilslutning (han)	1-1/4"
Indikation af elektrisk overbelastning	✓
Vægt (kg)	12,5
Varenr.	356H
DKK	36.024,00
Lager	-

Udstyret med 4-dobbelt sikkerhedsforanstaltning: elektronisk, mekanisk kobling, PRCD kontakt, startstrømbegrænsner



# BORESTATIV

Ref. 354H / BETON

## KAPACITET 250 MM

Til boremaskiner (Watt)	2.500 + 3.400
Boring Ø max. (mm)	250
Kan vippes	0° til 45°
Dimensioner (cm)	46 x 27 x 120
Vægt (kg)	15,0
Varenr.	354HD250
DKK	16.110,00
Lager	-



**KAPACITET 350 MM**

Til boremaskiner (Watt)	2.500 + 3.400
Boring Ø max. (mm)	350
Kan vippes	0° til 45°
Dimensioner (cm)	46 x 27 x 120
Vægt (kg)	22,0
Varenr.	355HD350
DKK	21.345,00
Lager	-





# DIAMANTKERNEBOR

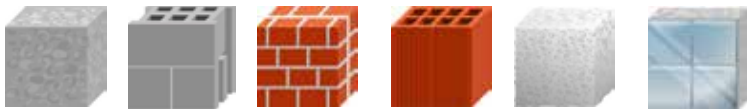

Beton, hul blok, mursten, hul mursten, cellulær beton og keramik.

Ref. 433 / BETON

## SEKSKANTET ADAPTER M16 X 320MM

Adapter med sekskantet skaft / M16 tilslutning.



L / mm	Varenr.	Indhold	DKK	Lager
100	433L0100	1	467,00	✓

Ref. 367 / BETON

## SDS-PLUS ADAPTER TIL HÅRDMETAL KERNEBOR

M16 tilslutning og SDS-plus skaft til kernebor 431, 432 og 366.



L / mm	Varenr.	Indhold	DKK	Lager
100	367L0100	1	419,00	✓
170	367L0170	1	504,00	-
220	367L0220	1	549,00	-
320	367L0320	1	640,00	-

Ref. 420 / BETON

## CENTRERINGSSTYR 8 X 210 MM

Skal fastgøres i midten af diamantkernebor.  
Fjernes lige efter at hullet er anboret.



Ø / mm	L / mm	Varenr.	Indhold	DKK	Lager
8	120	420D08L0120	1	91,00	✓

Ref. 427 / BETON

## RENSEBLOK

Rensblok 200 x 100 mm til diamantkernebor 431 og 432.



L / mm	Varenr.	Indhold	DKK	Lager
200	427	1	438,00	✓



# DIAMANTBOR



## DIAMANTBOR MED M14 GEVIND

Værktøj specielt designet til at bore alle typer fliser, takket være et hoved, der består af segmenter af premium kvalitet.

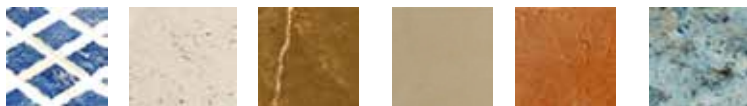

Fliser, stentøj, glaseret stentøj, keramiske fliser, porcelænsfliser, terrakotta og marmor.

Ref. 423 / SPECIAL	Ø / mm	Spiral L / mm	Total L / mm	Varenr.	Indhold	DKK	Lager
	6,0	40	80	423D06	1	221,00	✓
	7,0	40	80	423D07	1	230,00	✓
	8,0	40	80	423D08	1	239,00	✓
	10,0	45	80	423D10	1	247,00	✓
	12,0	45	80	423D12	1	261,00	✓
	13,0	45	80	423D13	1	282,00	✓
	15,0	45	80	423D15	1	295,00	✓
	20,0	80	80	423D20	1	344,00	✓
	25,0	80	80	423D25	1	375,00	-

## RENSEBLOK

Renseblok 60 x 40 x 20 mm til blå keramisk kernebor.



Ref. 417 / SPECIAL	Ø / mm	Spiral L / mm	Total L / mm	Varenr.	Indhold	DKK	Lager
	20,0	40	60	417	1	101,00	✓



# CARBID HULSAV



6-KANT



SDS-PLUS



ËN-HÅND BETJENT  
MULIGGØR HURTIG  
MONTERING OG SKIFT



HÅRDMETAL TÆNDER

FRA  
Ø 19-140  
MM

## ADAPTER KOMPATIBEL MED DIAMANT- OG HÅRDMETAL HULSAVE



EN  
HÅND



Adapter med sekskantet 8,5 eller SDS-Plus gør det muligt at skifte hulsaven i én arbejdsgang.

## LANG ADAPTER/REF.357J STYRER I ET EKSISTERENDE HUL



Der kan bruges 2 hårdmetal hulsave samtidig for at forbedre centrerung eller gøre eksisterende hul større.





## KERAMIK, TEGL, MARMOR



## SIMPEL OG HURTIG MONTERING



**BOREMASKINE**

**BOREHAMMER**





# ADAPTERE TIL HULSAV

## HÅRDMETAL ADAPTER TIL HULSAV

Adapter (én-hånds) HSS bor med sekskantet skaft.



Anvendes til træ og PVC

Ref. 357A / SPECIAL

Varenr.	357AH0635L125
DKK	378,00
Lager	✓

Ref. 357F / SPECIAL

### HSS CENTREBOR

Specielt tilpasset HM hulsav til boring af alle typer træ og plast.  
Ø 6,35 mm. Længde: 125 mm.



Varenr.	357FD0635L0125
DKK	88,00
Lager	✓

Ref. 357G / SPECIAL

### HM CENTREBOR

Specielt tilpasset HM hulsav til boring hule mursten og gipsplader.  
Ø 7 mm. Længde: 125 mm.



Varenr.	357GD07L0125
DKK	80,00
Lager	-

Ref. 357H / SPECIAL

### ADAPTER (Ø 19-30 MM)

Pakke med 3 stk., der skal skrues på en HM hulsav, der spænder fra Ø 19 til 30 mm.



Varenr.	357HD14030
DKK	222,00
Lager	-





## ADAPTER (Ø 32-140 MM)

Pakke med 3 stk., der skal skrues på en HM hulsav, der spænder fra Ø 32 til 140 mm.

Ref. 357I / SPECIAL

Varenr.	357ID32210
DKK	231,00
Lager	-



2-hulssav Ø 19-30 mm



1-hulssav Ø 19-30 mm  
+ 1-hulssav Ø 32-140 mm



2-hulssav Ø 32-140 mm

## 3 LANGE ADAPTERE TIL HULSAVE

Pakke med 3 stk.

Ref. 357J / SPECIAL

Varenr.	357JD14210
DKK	240,00
Lager	√

## MULTIFUNKTIONS HULSAVSSÆT (Ø 19-25-32-38-44-57-68 mm)

Hulsav med hårdmetal tandsæt til ren og højtydende skæring. Anvendes med centrerboret (énhåndssystem), hvilket giver en vigtig tidsbesparelse takket være låsning og oplåsning af saven i kun 1 bevægelse.



Ref. 3000E / SPECIAL

Varenr.	3000E
DKK	2.022,00
Lager	√

**INDHOLD:** Hårdmetal hulsave (Ø 19-25-32-38-44-57-68 mm) + adapter énhånds med sekskantet skaft 8,5 mm med HSS centrerboret + 1 hårdmetal centrerboret + 1 unbrakonøgle



# UNIVERSAL BOR

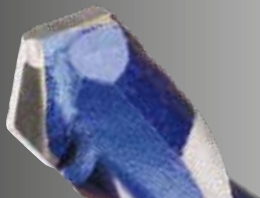

## BOR I FLERE MATERIALER MED CYLINDRISK SKAFT

Den slebne hårdmetalspids gør det muligt at bore meget hårde materialer såsom højstyrkestål (låse, pengeskabe), hule mursten og kompositmaterialer. Brug ikke slagfunktion til boring.



Blødt træ, legeret stål, keramiske fliser, skifer, komposit og mursten.

Ref. 215 / SPECIAL

Ø / mm	Spiral L / mm	Total L / mm	Varenr.	Indhold	DKK	Lager
3,0	20	60	215D03	1	50,00	✓
4,0	35	75	215D04	1	50,00	✓
5,0	45	85	215D05	1	53,00	✓
5,5	55	95	215D055	1	76,00	✓
6,0	60	100	215D06	1	61,00	✓
6,0	210	250	215D06L0250	1	148,00	✓
6,5	60	100	215D065	1	63,00	✓
6,5	210	250	215D065L0250	1	159,00	✓
7,0	60	100	215D07	1	63,00	✓
8,0	80	120	215D08	1	67,00	✓
8,0	210	250	215D08L0250	1	173,00	✓
9,0	80	120	215D09	1	69,00	✓
10,0	260	300	215D10L0300	1	155,00	✓
10,0	260	300	215D10L0300	1	155,00	✓
12,0	110	150	215D12	1	93,00	✓
12,0	260	300	215D12L0300	1	176,00	✓
13,0	110	150	215D13	1	101,00	✓
13,0	260	300	215D13L0300	1	183,00	✓
14,0	110	150	215D14	1	115,00	✓
16,0	110	150	215D16	1	126,00	✓

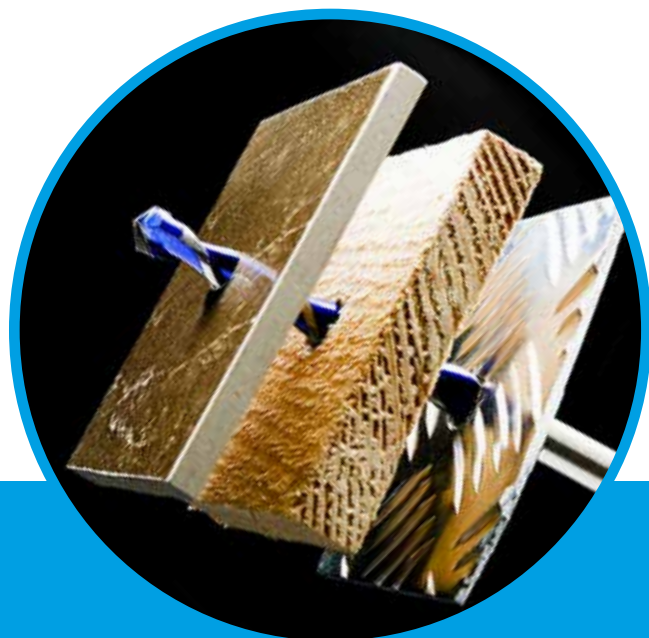



# BOR / OMDREJNINGSTAL

## HAMMERBOR / SDS-PLUS

Ø	O/MIN.
3	850
4	850
5	850
6	850
7	850
8	650
9	650
10	650
11	650
12	650
13	650
14	650
16	650
18	650
20	650
22	650
24	650
26	650
28	650
30	650
30 OG +	650

## BOR

Ø	KORT SERIE	LANG SERIE
3	3 185	-
4	2 390	-
5	1 910	-
6	1 590	800
7	1 365	800
8	1 195	900
9	1 060	900
10	955	955
11	870	870
12	800	800
13	735	735
14	680	680
16	600	600
18	530	530
20	475	475
22	435	430
24	400	400
26	365	370
28	340	340
30	320	320

## METALBOR

Ø	STÅL 750N/mm <sup>2</sup>	STÅL 1100N/mm <sup>2</sup>
1	6 400	3200
2	3 200	1590
3	2 120	1060
4	1 590	795
5	1 275	635
6	1 060	530
7	910	455
8	800	400
9	700	355
10	640	320
11	580	290
12	530	265
13	500	245
14	455	225
16	400	200
18	355	175
20	320	160
22	290	145
24	265	135
26	245	120
28	225	115
30	210	105

## BOR TIL ALLE MATERIALER

Ø	PLASTIK	STÅL 750N/mm <sup>2</sup>	STÅL 1100N/mm <sup>2</sup>	GLAS	HÅRDT TRÆ	KRYDSFINER
4	4 775	1 590	795	400	3 000	3 000
6	3 185	1 060	530	285	3 000	3 000
8	2 385	800	400	220	3 000	3 000
10	1 910	640	320	170	3 000	3 000
12	1 590	530	265	140	1 500	1 500
14	1 365	455	225	125	1 500	1 500
16	1 195	400	200	110	1 500	1 500

## GLAS BOR

Ø	O/MIN.
3	500
4	400
5	330
6	285
8	220
10	170
12	140
14	125

## FLADBOR

Ø	O/MIN.
8	2785
9	2500
10	2230
11	2030
12	1860
13	1715
14	1590
16	1395
18	1240
20	1115
22	1015
24	930
26	860
28	800
30	745
32	700
35	640

## SNEGLEBOR

Ø	SOFTWOOD	HÅRDTTRÆ
8	3 000	2090
9	2 970	2040
10	2900	1900
11	2 880	1765
12	2825	1615
13	2735	1500
14	2630	1410
15	2500	1250
16	2425	1205
17	2325	1130
18	1060	1060
19	1000	1000
20	900	900
21	880	880
22	855	855
23	810	810
24	780	780
25	700	700

## TRÆBOR

Ø	SOFTWOOD	HÅRDTTRÆ
3	5625	4985
4	4220	3740
5	3375	2990
6	2810	2495
7	2410	2135
8	2110	1870
9	1875	1660
10	1690	1495
11	1535	1360
12	1405	1245
13	1300	1150
14	1205	1070
16	1055	935
18	935	830
20	845	750



Østerby Agentur A/S - Rønnevej 7 - 4060 Kirke Såby  
Telefon 46 48 00 61 - [www.oeag.dk](http://www.oeag.dk)

10.05.2023

Alle priser er enhedspriser angivet i danske kroner og er ekskl. moms. Vi tager forbehold for trykfejl og udsolgte varer.