





Ringgaffelnøgler.

Forkrommet, krom vanadium.
DIN 3113 A / ISO 7738.

MM	L mm	Art. nr.	DKK	Lager
6	100	50810006080	32,00	✓
7	110	50810007080	32,00	✓
8	120	50810008080	33,00	✓
9	130	50810009080	34,00	✓
10	140	50810010080	34,00	✓
11	150	50810011080	36,00	✓
12	160	50810012080	40,00	✓
13	170	50810013080	44,00	✓
14	180	50810014080	48,00	✓
15	190	50810015080	48,00	✓
16	200	50810016080	50,00	✓
17	210	50810017080	52,00	✓
18	220	50810018080	64,00	✓
19	230	50810019080	78,00	✓
20	240	50810020080	78,00	✓
21	250	50810021080	85,00	✓
22	260	50810022080	102,00	✓
24	280	50810024080	124,00	✓
27	310	50810027080	155,00	✓
30	340	50810030080	184,00	✓
32	360	50810032080	189,00	✓
36	400	50810036080	438,00	✓
41	450	50810041080	635,00	✓



Ringgaffelnøgle sæt.

Forkrommet, krom vanadium.
DIN 3113 A / ISO 7738.

MM	Antal	Art. nr.	DKK	Lager
8-10-12-13-14-15-17-19 Karton	8	50810724280	358,00	✓
6-7-8-9-10-11-12-13-14-17- 19-22 Rullemappe	12	50810727180	523,00	✓
6-7-8-9-10-11-12-13-14-15 16-17-18-19-20-21-22-24-27- 30-32 Rullemappe	21	50810729480	1.190,00	✓



Ringgaffelnøgler med skralde.



Forkromet, krom vanadium, 72 td.
Skralde DIN 899 række / ISO 1711-1.
Ringgaffel DIN 899 række C /ISO 1711.

 MM	L mm	Art. nr.	DKK	Lager
8	140,0	50720008080	135,00	✓
9	150,0	50720009080	140,00	✓
10	160,0	50720010080	141,00	✓
11	165,0	50720011080	147,00	✓
12	172,0	50720012080	157,00	✓
13	178,0	50720013080	168,00	✓
14	190,0	50720014080	170,00	✓
15	200,0	50720015080	178,00	✓
16	207,0	50720016080	190,00	✓
17	225,0	50720017080	197,00	✓
18	240,0	50720018080	211,00	✓
19	248,0	50720019080	216,00	✓
22	278,0	50720022080	250,00	✓
24	300,8	50720024080	298,00	✓
27	304,1	50720027080	430,00	✓



Ringgaffelnøgler med skralde.



Forkromet, krom vanadium, 72 td.
Skralde DIN 899 række / ISO 1711-1.
Ringgaffel DIN 899 række C /ISO 1711.

 MM	Antal	Art. nr.	DKK	Lager
8-10-12-13-17-19 Rullemappe	6	50720600180	987,00	✓
8-10-12-13-14-15-17-19 Rullemappe	8	50720600380	1.276,00	✓
8-10-12-13-14-15-16-17-18-19 Plastbox	10	50720600280	1.719,00	✓



Ringgaffelnøgler med skralde og omskifter.



Forkromet, krom vanadium, 72 td.
Skralde DIN 899 række / ISO 1711-1.
Ringgaffel DIN 899 række C /ISO 1711.

MM	L mm	Art. nr.	DKK	Lager
8	140,0	50725008080	183,00	✓
9	150,0	50725009080	183,00	✓
10	160,0	50725010080	192,00	✓
11	165,0	50725011080	192,00	✓
12	170,0	50725012080	197,00	✓
13	178,0	50725013080	197,00	✓
14	190,0	50725014080	230,00	✓
15	200,0	50725015080	230,00	✓
16	210,0	50725016080	272,00	✓
17	225,0	50725017080	272,00	✓
18	237,0	50725018080	292,00	✓
19	248,0	50725019080	292,00	✓
22	290,0	50725022080	432,00	✓
24	335,0	50725024080	521,00	✓
27	353,0	50725027080	532,00	✓
30	419,0	50725030080	679,00	✓
32	420,0	50725032080	705,00	✓



Ringgaffelnøgler med skralde og omskifter.



Forkromet, krom vanadium, 72 td.
Skralde DIN 899 række / ISO 1711-1.
Ringgaffel DIN 899 række C /ISO 1711.

	Antal	Art. nr.	DKK	Lager
8-10-12-13-17-19 Rullemappe	6	50725600180	1.209,00	✓
8-10-12-13-14-15-17-19 Rullemappe	8	50725600380	1.652,00	✓
8-10-11-12-13-14-16-17-18-19 Plastbox	10	50725600280	1.874,00	✓

50839

Svensknøgle.

Forkromet, krom vanadium.

1/4"

MM/AF		Længde mm	Antal	Art. nr.	DKK	Lager
0-20	0 - 1/4"	160	5	50839000680	119,00	✓
0-25	0 - 1"	205	5	50839000880	149,00	✓
0-30	0 - 1.1/4"	255	5	50839001080	211,00	✓
0-35	0 - 1.1/2"	305	5	50839001280	274,00	✓

50825-00-15

Skralde 1/4" med 2-komponent håndtag.

Forkromet, krom vanadium, 48 td.
DIN 3122 D / ISO 3315.**1/4"**

□■	Længde mm	Antal	Art. nr.	DKK	Lager
1/4"	150	1	50825015083	225,00	✓

50825-10-17

Skralde 1/4" med låsbart hoved og ergonomisk 2-komponent håndtag.

Forkromet, krom vanadium, 60 td.

1/4"

□■	Længde mm	Antal	Art. nr.	DKK	Lager
1/4"	150	1	50825101783	225,00	✓

50825-00-17

Skralde 1/4" med bevægeligt, låsbar hoved og ergonomisk 2-komponent håndtag samt bælte klips.

Forkromet, krom vanadium, 48 td.

1/4"

□■	Længde mm	Antal	Art. nr.	DKK	Lager
1/4"	140	1	50825017083	308,00	✓

50825-00-18

T-greb 1/4" i støbt zink med skraldefunktion, samt højre/venstre omskifter.

1/4"

	Længde mm	Antal	Art. nr.	DKK	Lager
1/4"	115	1	50825018083	254,00	✓

50825-10-15

Skralde 1/4" Composit med stålkerne overtrukket med en 2-komponent plast belægning.

1/4"

Forkromet, krom vanadium, 48 td.
DIN 3122 D / ISO 3315.

	Længde mm	Antal	Art. nr.	DKK	Lager
1/4"	148	1	50825101500	260,00	✓

50825-03

T-Greb 1/4".

1/4"

Forkromet, krom vanadium.
DIN 3123 B / ISO 3316.

	Længde mm	Antal	Art. nr.	DKK	Lager
1/4"	115	1	50825030083	45,00	✓

50825-04 / 50825-05

Forlænger 1/4".

1/4"

Forkromet, krom vanadium.
DIN 3123 B / ISO 3316.

	Længde mm	Antal	Art. nr.	DKK	Lager
1/4"	50	1	50825040083	26,00	✓
1/4"	100	1	50825050083	29,00	✓

50825-05-5

Forlænger 1/4" med kugleled.

Forkromet, krom vanadium.
DIN 3123 B / ISO 3316.

1/4"

	Længde mm	Antal	Art. nr.	DKK	Lager
1/4"	102	1	50825055083	47,00	✓

50825-05-6 / 50825-05-07

Forlænger 1/4" med hurtigskift/holder.

1/4"

	Længde mm	Antal	Art. nr.	DKK	Lager
1/4"	100	1	50825056083	89,00	✓
1/4"	250	1	50825057083	121,00	✓

50825-06

Kardanled 1/4".

DIN 3123 C / ISO 3316.

1/4"

	Længde mm	Antal	Art. nr.	DKK	Lager
1/4"	37	1	50825060083	63,00	✓

50825-08

Skruetrækker med 1/4" tilslutning.

DIN 3122 E / ISO 3315.



	Længde mm	Antal	Art. nr.	DKK	Lager
1/4"	150	1	50825080083	45,00	✓

50800-3306

Top til 1/4" bits.

Forkrommet, krom vanadium.



	Længde mm	Antal	Art. nr.	DKK	Lager
1/4"	25	1	50800330683	19,00	✓

50825-6

Top 1/4"

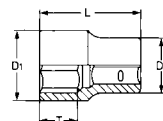
 Forkrommet, krom vanadium.
 DIN 3124 / ISO 2725.

	L mm	T mm	D1 mm	D2 mm	Art. nr.	DKK	Lager
4,0	25,0	9,0	7,0	12,0	50825600483	24,00	✓
4,5	25,0	9,0	7,0	12,0	50825604583	24,00	✓
5,0	25,0	9,0	8,0	12,0	50825600583	24,00	✓
5,5	25,0	9,0	9,0	12,0	50825605583	24,00	✓
6,0	25,0	9,0	9,0	12,0	50825600683	24,00	✓
7,0	25,0	9,0	10,0	12,0	50825600783	24,00	✓
8,0	25,0	9,0	12,0	12,0	50825600883	24,00	✓
9,0	25,0	11,0	13,0	13,0	50825600983	24,00	✓
10,0	25,0	11,0	14,0	14,0	50825601083	24,00	✓
11,0	25,0	12,0	16,0	16,0	50825601183	30,00	✓
12,0	25,0	13,0	17,0	17,0	50825601283	30,00	✓
13,0	25,0	13,0	18,0	18,0	50825601383	30,00	✓
14,0	25,0	14,0	19,5	19,5	50825601483	32,00	✓
15,0	25,0	15,0	21,5	21,5	50825601583	36,00	✓





50825-19

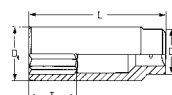

Top lang 1/4".

Forkrommet, krom vanadium.
DIN 3124 / ISO 2725.



 MM	L mm	T mm	D1 mm	D2 mm	Art. nr.	DKK	Lager
6,0	50,0	12,0	10,0	12,0	50825190683	40,00	✓
7,0	50,0	19,0	10,5	12,0	50825190783	40,00	✓
8,0	50,0	19,0	12,0	12,0	50825190883	40,00	✓
9,0	50,0	19,0	13,0	12,0	50825190983	40,00	✓
10,0	50,0	21,0	14,5	13,0	50825191083	42,00	✓
11,0	50,0	23,0	16,0	14,0	50825191183	43,00	✓
12,0	50,0	23,0	17,0	15,0	50825191283	44,00	✓
13,0	50,0	23,0	18,0	16,0	50825191383	44,00	✓
14,0	50,0	23,0	19,0	17,0	50825191483	47,00	✓

50825-20



Top 1/4" med Torx indvendig.

Forkrommet, krom vanadium.

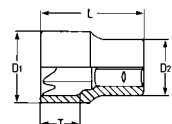

 E	 mm	L mm	L1 mm	L2 mm	D2 mm	Art. nr.	DKK	Lager
4	3,86	25,0	7,0	7,0	12,0	50825200483	41,00	✓
5	4,75	25,0	7,0	8,0	12,0	50825200583	41,00	✓
6	5,74	25,0	7,0	9,0	12,0	50825200683	41,00	✓
7	6,22	25,0	12,0	11,0	12,0	50825200783	41,00	✓
8	7,52	25,0	12,0	12,0	12,0	50825200883	41,00	✓
10	9,42	25,0	12,0	14,0	14,0	50825201083	44,00	✓
11	10,08	25,0	12,0	16,0	16,0	50825201183	44,00	✓

50825-30



Bitstop lige kærν 1/4".

Forkromet, krom vanadium.

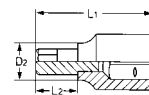

		L1 mm	L2 mm	D2 mm	Art. nr.	DKK	Lager
4,0	0,7	36,0	18,0	12,0	50825300383	30,00	✓
5,5	0,9	36,0	18,0	12,0	50825300483	30,00	✓
7,0	1,0	36,0	18,0	12,0	50825300583	30,00	✓

50825-31



Top Sekskant 1/4".

Forkromet, krom vanadium.

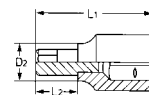

 MM	L1 mm	L2 mm	D2 mm	Art. nr.	DKK	Lager
3	36,0	17,0	12,0	50825310183	30,00	✓
4	36,0	17,0	12,0	50825310283	30,00	✓
5	36,0	17,0	12,0	50825310383	30,00	✓
6	36,0	17,0	12,0	50825310483	30,00	✓

50825-32



Bitstop PH 1/4".

Forkromet, krom vanadium.

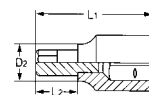

	L1 mm	L2 mm	D2 mm	Art. nr.	DKK	Lager
PH 1	36,0	17,0	12,0	50825320183	30,00	✓
PH 2	36,0	17,0	12,0	50825320283	30,00	✓
PH 3	36,0	17,0	12,0	50825320383	30,00	✓

50825-33



Top XZN 1/4".

Forkromet, krom vanadium.

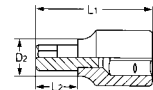

	L 1 mm	L2 mm	D2 mm	Art. nr.	DKK	Lager
M5	36,0	17,0	12,0	50825330183	36,00	✓
M6	36,0	17,0	12,0	50825330283	36,00	✓
M8	36,0	17,0	12,0	50825330383	36,00	✓

50825-35



Top PZ 1/4".

Forkromet, krom vanadium.

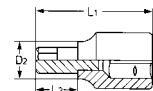

	L 1 mm	L2 mm	D2 mm	Art. nr.	DKK	Lager
PZ 1	36,0	17,0	12,0	50825350183	36,00	✓
PZ 2	36,0	17,0	12,0	50825350283	36,00	✓
PZ 3	36,0	17,0	12,0	50825350383	36,00	✓



50825-37

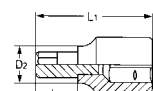

Top torx med hul 1/4".

Forkromet, krom vanadium.



	 mm	L1 mm	L2 mm	D2 mm	Art. nr.	DKK	Lager
T 8	2,52	37,0	17,0	12,0	50825370883	38,00	✓
T 10	2,68	37,0	17,0	12,0	50825371083	38,00	✓
T 15	3,48	37,0	17,0	12,0	50825371583	38,00	✓
T 20	3,75	37,0	17,0	12,0	50825372083	38,00	✓
T 25	4,25	37,0	17,0	12,0	50825372583	38,00	✓
T 27	5,00	37,0	17,0	12,0	50825372783	38,00	✓
T 30	5,55	37,0	17,0	12,0	50825373083	38,00	✓
T 40	6,50	37,0	17,0	12,0	50825374083	38,00	✓

50840-00-15

Skralde 3/8" med 2-komponent håndtag.

3/8"

48 td.
DIN 3122 D / ISO 3315.

	Længde mm	Antal	Art. nr.	DKK	Lager
3/8"	250	1	50840015083	313,00	✓

50840-03

T-Greb 3/8".

3/8"

Forkrommet, krom vanadium.
DIN 3122 A / ISO 3315.

	Længde mm	Antal	Art. nr.	DKK	Lager
3/8"	150	1	50840030083	106,00	✓

50840-04 / 50840-04-01

Forlænger 3/8".

3/8"

Forkrommet, krom vanadium.
DIN 3123 B / ISO 3316.

 MM

	Længde mm	Antal	Art. nr.	DKK	Lager
3/8"	75	1	50840041083	28,00	✓
3/8"	150	1	50840040083	42,00	✓

50840-06

Kardanled 3/8".

3/8"

Krom vanadium.
DIN 3123 C / ISO 3316.

	Længde mm	Antal	Art. nr.	DKK	Lager
3/8"	55	1	50840060083	79,00	✓

50840-14/-15 850-14-1

50840-14-1



50840-14 / 50840-15

Adapter.

 Forkromet, krom vanadium.
 DIN 3123 B / ISO 3316.

		Længde mm	Antal	Art. nr.	DKK	Lager
3/8"	1/4"	25	1	50840140083	37,00	✓
3/8"	1/2"	45	1	50840150083	45,00	✓
1/2"	3/8"	40	1	50850141083	42,00	✓

50840-06

Top 3/8".

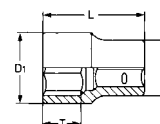
 Forkromet, krom vanadium.
 DIN 3123 B / ISO 3316.

	L mm	T mm	D1 mm	D2 mm	Art. nr.	DKK	Lager
8,0	25,5	10,0	12,5	12,0	50840600883	30,00	✓
9,0	28,0	10,0	17,0	13,0	50840600983	30,00	✓
10,0	28,0	12,0	14,5	17,0	50840601083	30,00	✓
11,0	25,5	12,0	15,5	17,0	50840601183	30,00	✓
12,0	25,5	10,0	17,0	17,0	50840601283	30,00	✓
13,0	25,5	11,0	18,5	17,0	50840601383	30,00	✓
14,0	25,5	15,0	20,0	18,0	50840601483	36,00	✓
15,0	25,5	15,0	21,0	19,5	50840601583	36,00	✓
16,0	25,5	16,0	22,0	19,5	50840601683	40,00	✓
17,0	25,5	17,0	23,0	20,0	50840601783	40,00	✓
18,0	26,0	17,0	24,5	21,0	50840601883	45,00	✓
19,0	26,5	17,0	26,0	23,0	50840601983	45,00	✓
20,0	32,0	18,0	27,0	24,0	50840602083	50,00	✓
21,0	32,0	18,0	28,0	25,0	50840602183	50,00	✓
22,0	32,0	18,0	29,5	26,5	50840602283	50,00	✓
24,0	32,0	18,0	32,0	28,0	50840602483	61,00	✓



Tændrørstop 3/8".

Forkromet med gummi indsats, krom vanadium.

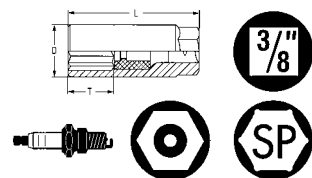

MM	L mm	T mm	D mm	MM	Art. nr.	DKK	Lager
20,8	70,0	25,0	27,0	24,0	50840190183	78,00	✓
16,0	65,0	20,0	22,5	19,0	50840190383	62,00	✓



Skralde 1/2" med 2-komponent håndtag.

1/2"

48 td.
DIN 3122 D / ISO 3315.

■	Længde mm	Antal	Art. nr.	DKK	Lager
1/2"	250	1	50850015083	379,00	✓

50850-10-17

Skralde 1/2" med 2-komponent håndtag.

60 td.

1/2"

	Længde mm	Antal	Art. nr.	DKK	Lager
1/2"	260	1	50850101783	402,00	✓

50850-10-16

Skralde 1/2" med stålkerne.

72 td.

1/2"

	Længde mm	Antal	Art. nr.	DKK	Lager
1/2"	255	1	50850101680	414,00	✓

50850-03

T-Greb 1/2".

Forkromet, krom vanadium.
DIN 3122 A / ISO 3315.**1/2"**

	Længde mm	Antal	Art. nr.	DKK	Lager
1/2"	250	1	50850030083	140,00	✓

50850-04-5/ 50850-05-5

Forlænger 1/2".

1/2"

Forkromet, krom vanadium.
DIN 3123 B / ISO 3316.

	Længde mm	Antal	Art. nr.	DKK	Lager
1/2"	125	1	50850040083	64,00	✓
1/2"	250	1	50850050083	101,00	✓

50850-04-5/ 50850-05-5

Forlænger med kugleled 1/2".

1/2"

Forkromet, krom vanadium.
DIN 3123 B / ISO 3316.

	Længde mm	Antal	Art. nr.	DKK	Lager
1/2"	125	1	50850045083	108,00	✓
1/2"	250	1	50850055083	165,00	✓

50850-06

Kardanled 1/2".

1/2"

DIN 3123 C / ISO 3316.

	Længde mm	Antal	Art. nr.	DKK	Lager
1/2"	75	1	50850060083	101,00	✓

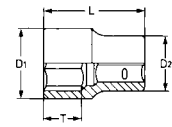

Top 1/2".

Forkrommet, krom vanadium.
DIN 3124 / ISO 2725.

 MM	L mm	T mm	D1 mm	D2 mm	Art. nr.	DKK	Lager
8,0	38,5	14,0	13,5	22,0	50850600883	43,00	✓
9,0	38,5	14,0	14,5	22,0	50850600983	43,00	✓
10,0	38,5	14,0	15,5	22,0	50850601083	43,00	✓
11,0	38,5	14,0	16,5	22,0	50850601183	43,00	✓
12,0	38,5	14,0	17,5	22,0	50850601283	43,00	✓
13,0	38,5	14,0	18,5	22,0	50850601383	43,00	✓
14,0	38,5	14,0	20,0	22,0	50850601483	43,00	✓
15,0	38,5	14,0	21,5	22,0	50850601583	50,00	✓
16,0	38,5	14,0	22,5	22,0	50850601683	50,00	✓
17,0	38,5	14,0	24,0	22,5	50850601783	50,00	✓
18,0	38,5	14,0	25,0	23,0	50850601883	57,00	✓
19,0	38,5	20,0	25,0	24,5	50850601983	57,00	✓
20,0	38,5	20,0	28,0	25,5	50850602083	58,00	✓
21,0	38,5	20,0	28,0	26,5	50850602183	58,00	✓
22,0	38,5	20,0	30,0	28,0	50850602283	66,00	✓
23,0	40,0	20,0	32,0	28,0	50850602383	66,00	✓
24,0	40,5	22,0	32,0	30,0	50850602483	81,00	✓
27,0	42,5	22,0	36,0	34,0	50850602783	99,00	✓
30,0	42,5	22,0	40,0	36,5	50850603083	112,00	✓
32,0	45,0	23,0	42,0	38,0	50850603283	120,00	✓

50850-6



Top 1/2".

Forkromet, krom vanadium.
DIN 3124 / ISO 2725.

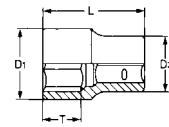

 AF	L mm	T mm	D1 mm	D2 mm	Art. nr.	DKK	Lager
3/8"	38,0	12,0	15,0	22,0	50850631983	44,00	✓
7/16"	38,0	12,0	16,3	22,0	50850632183	44,00	✓
1/2"	38,0	12,0	18,8	22,0	50850632383	44,00	✓
9/16"	38,0	12,0	20,4	22,0	50850632583	44,00	✓
5/8"	38,0	12,0	22,9	22,0	50850632783	44,00	✓
11/16"	38,0	12,0	24,0	22,0	50850632983	53,00	✓
3/4"	38,0	14,0	26,0	23,0	50850633183	53,00	✓
13/16"	38,0	14,0	28,0	25,0	50850633383	60,00	✓
7/8"	40,0	14,0	30,0	30,0	50850633483	66,00	✓
15/16"	42,0	16,0	32,0	28,0	50850633583	80,00	✓
1"	42,0	16,0	34,0	30,0	50850633783	100,00	✓
1.1/16"	43,0	18,0	36,0	30,0	50850633883	111,00	✓
1.1/8"	43,0	20,0	38,0	32,0	50850633983	117,00	✓
1.3/16"	46,0	22,0	40,0	34,0	50850634083	123,00	✓
1.1/4"	46,0	22,0	42,0	36,0	50850634183	128,00	✓

50850-19



Top Lang 1/2".

Forkromet, krom vanadium.
DIN 3124 / ISO 2725.

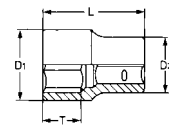

 MM	L mm	T mm	D1 mm	D2 mm	Art. nr.	DKK	Lager
10	77,0	35,0	14,8	22,0	50850191083	80,00	✓
13	77,0	35,0	18,8	22,0	50850191383	87,00	✓
14	77,0	35,0	20,5	22,0	50850191483	87,00	✓
15	77,0	35,0	22,0	22,0	50850191583	87,00	✓
17	77,0	35,0	24,0	22,0	50850191783	89,00	✓
19	77,0	35,0	26,0	23,0	50850191983	99,00	✓
22	77,0	35,0	26,0	24,0	50850192283	105,00	✓
24	77,0	35,0	28,0	24,0	50850192483	116,00	✓

50850-19-1 / 50850-19-3



Tændrørstop 1/2".

Forkromet med gummiindsats, krom vanadium.

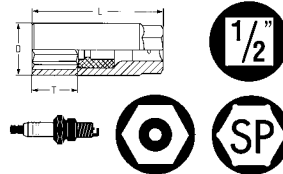

MM	L mm	T mm	D mm	MM	Art. nr.	DKK	Lager
20,8	70,0	21,5	28,0	24,0	50850190183	78,00	✓
16,0	65,0	18,0	23,0	21,0	50850190383	60,00	✓

50850-20



Top E 1/2".

Forkromet, krom vanadium.

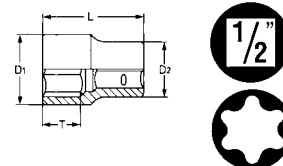



E	mm	L mm	T mm	D1 mm	D2 mm	Art. nr.	DKK	Lager
E 10	9,42	38,0	14,0	15,0	22,0	50850201083	78,00	✓
E 11	10,08	38,0	14,0	15,0	22,0	50850201183	78,00	✓
E 12	11,17	38,0	14,0	15,0	22,0	50850201283	78,00	✓
E 14	12,90	38,0	14,0	17,0	22,0	50850201483	78,00	✓
E 16	14,76	38,0	14,0	19,0	22,0	50850201683	78,00	✓
E 18	16,70	38,0	14,0	21,0	24,0	50850201883	81,00	✓
E 20	18,49	38,0	14,0	24,0	22,0	50850202083	85,00	✓
E 22	20,32	38,0	14,0	26,0	23,0	50850202283	85,00	✓
E 24	22,16	38,0	14,0	28,0	24,0	50850202483	88,00	✓

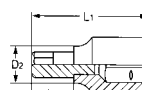

Top sekskant 1/2".

Forkromet, krom vanadium.



 MM	L 1 mm	L 2 mm	D 2 mm	Art. nr.	DKK	Lager
4	62,0	24,0	18,0	50850310083	67,00	✓
4	138,0	100,0	18,0	50850311383	94,00	✓
5	62,0	24,0	18,0	50850310283	67,00	✓
5	138,0	100,0	18,0	50850311483	94,00	✓
6	62,0	24,0	18,0	50850310383	67,00	✓
6	100,0	62,0	18,0	50850312283	92,00	✓
6	138,0	100,0	18,0	50850311583	95,00	✓
7	62,0	24,0	18,0	50850310183	67,00	✓
7	138,0	100,0	18,0	50850311683	94,00	✓
8	62,0	24,0	18,0	50850310483	67,00	✓
8	100,0	62,0	18,0	50850312483	92,00	✓
8	138,0	100,0	18,0	50850311283	94,00	✓
10	62,0	24,0	18,0	50850310583	74,00	✓
10	100,0	62,0	18,0	50850312583	105,00	✓
10	138,0	100,0	18,0	50850311183	113,00	✓
12	62,0	24,0	20,0	50850310683	77,00	✓
12	100,0	62,0	20,0	50850312683	116,00	✓
12	138,0	100,0	20,0	50850311883	132,00	✓
14	62,0	24,0	22,0	50850310783	85,00	✓
14	100,0	62,0	22,0	50850312783	130,00	✓
14	138,0	100,0	22,0	50850311783	164,00	✓
17	62,0	24,0	26,0	50850310883	107,00	✓
17	138,0	100,0	26,0	50850311083	217,00	✓
19	62,0	24,0	26,0	50850310983	116,00	✓
19	138,0	100,0	26,0	50850311983	254,00	✓

50850-33



Top XZN 1/2".

Forkromet, krom vanadium.

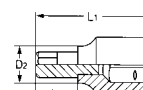

	L 1 mm	L2 mm	D2 mm	Art. nr.	DKK	Lager
M5	62,0	24,0	18,0	50850330183	88,00	✓
M5	138,0	100,0	18,0	50850332183	127,00	✓
M6	62,0	24,0	18,0	50850330283	88,00	✓
M6	100,0	62,0	18,0	50850331283	95,00	✓
M6	138,0	100,0	18,0	50850332283	127,00	✓
M7	62,0	24,0	18,0	50850330383	88,00	✓
M7	138,0	100,0	18,0	50850332383	127,00	✓
M8	62,0	24,0	18,0	50850330483	88,00	✓
M8	100,0	62,0	18,0	50850331483	95,00	✓
M8	138,0	100,0	18,0	50850332483	127,00	✓
M10	62,0	24,0	18,0	50850330583	91,00	✓
M10	100,0	62,0	18,0	50850331583	100,00	✓
M10	138,0	100,0	18,0	50850332583	160,00	✓
M12	62,0	24,0	20,0	50850330683	105,00	✓
M12	100,0	62,0	20,0	50850331683	131,00	✓
M12	138,0	100,0	20,0	50850332683	178,00	✓
M14	62,0	24,0	22,0	50850330783	116,00	✓
M14	138,0	100,0	22,0	50850332783	211,00	✓

50850-37



Top 1/2" torx med hul.

Forkromet, krom vanadium.

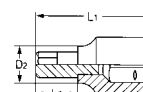



	 mm	L1 mm	L2 mm	D2 mm	Art. nr.	DKK	Lager
TT 20	3,86	62,0	24,0	18,0	50850372083	78,00	✓
TT 25	4,43	62,0	24,0	18,0	50850372583	78,00	✓
TT 27	4,99	62,0	24,0	18,0	50850372783	78,00	✓
TT 30	5,62	62,0	24,0	18,0	50850373083	78,00	✓
TT 40	6,65	62,0	24,0	18,0	50850374083	78,00	✓
TT 45	7,82	62,0	24,0	18,0	50850374583	78,00	✓
TT 50	8,83	62,0	24,0	18,0	50850375083	78,00	✓
TT 55	11,22	62,0	24,0	18,0	50850375583	86,00	✓
TT 60	13,25	62,0	24,0	18,0	50850376083	95,00	✓

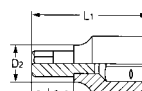

Top 1/2" torx.

Forkromet, krom vanadium.



	 mm	L1 mm	L2 mm	D2 mm	Art. nr.	DKK	Lager
T 20	3,86	62,0	24,0	18,0	50850362083	78,00	✓
T 20	3,86	138,0	100,0	18,0	50850361083	107,00	✓
T 25	4,43	62,0	24,0	18,0	50850362583	78,00	✓
T 25	4,43	138,0	100,0	18,0	50850361183	107,00	✓
T 27	4,99	62,0	24,0	18,0	50850362783	78,00	✓
T 27	4,99	138,0	100,0	18,0	50850361283	107,00	✓
T 30	5,62	62,0	24,0	18,0	50850363083	78,00	✓
T 30	5,62	100,0	62,0	18,0	50850360383	93,00	✓
T 30	5,62	138,0	100,0	18,0	50850361383	107,00	✓
T 40	6,65	62,0	24,0	18,0	50850364083	78,00	✓
T 40	6,65	100,0	62,0	18,0	50850360483	93,00	✓
T 40	6,65	138,0	100,0	18,0	50850361483	107,00	✓
T 45	7,82	62,0	24,0	18,0	50850364583	78,00	✓
T 45	7,82	138,0	100,0	18,0	50850361583	107,00	✓
T 50	8,83	62,0	24,0	18,0	50850365083	78,00	✓
T 50	8,83	100,0	62,0	18,0	50850360683	93,00	✓
T 50	8,83	138,0	100,0	18,0	50850361683	107,00	✓
T 55	11,22	62,0	24,0	18,0	50850365583	83,00	✓
T 55	11,22	138,0	100,0	18,0	50850361783	137,00	✓
T 60	13,25	62,0	34,0	20,0	50850366083	94,00	✓
T 60	13,25	100,0	62,0	20,0	50850360883	127,00	✓
T 60	13,25	138,0	100,0	20,0	50850361883	157,00	✓
T 70	13,25	62,0	24,0	20,0	50850367083	105,00	✓
T 70	13,25	138,0	100,0	20,0	50850361983	199,00	✓

50850-1501

Adapter.

Forkrommet, krom vanadium.
DIN 3123 A / ISO 3316.

		Længde mm	Antal	Art. nr.	DKK	Lager
1/2"	3/4"	50	1	50850150183	73,00	√

50810-1401

Adapter.

Forkrommet, krom vanadium.
DIN 3123 A / ISO 3316.

		Længde mm	Antal	Art. nr.	DKK	Lager
3/4"	1/2"	50	1	50810140180	95,00	√

508100-00-6

Skralde 3/4".

DIN 3122 D / ISO 3315.



		Længde mm	Antal	Art. nr.	DKK	Lager
3/4"		510	1	50810000680	1.327,00	√

508100-03



T-Greb 3/4".

Forkrommet, krom vanadium.
DIN 3122 A / ISO 3315.

		Længde mm	Antal	Art. nr.	DKK	Lager
3/4"		455	1	50810003080	402,00	√

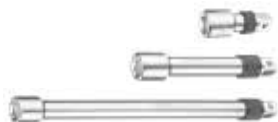
Forlænger 3/4" med modhold.



 	Længde mm	Antal	Art. nr.	DKK	Lager
3/4"	100	1	50810004180	248,00	✓
3/4"	200	1	50810004080	319,00	✓
3/4"	400	1	50810005080	414,00	✓

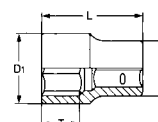

Top 3/4".

Forkrommet, krom vanadium.
DIN 3124 / ISO 2725.

	L mm	T mm	D1 mm	D2 mm	Art. nr.	DKK	Lager
21,0	50,0	15,0	29,0	33,0	50810061980	120,00	✓
22,0	50,0	15,0	31,0	33,0	50810062180	120,00	✓
23,0	50,0	15,0	33,0	36,0	50810062280	120,00	✓
24,0	50,0	15,0	33,0	36,0	50810062380	120,00	✓
26,0	50,0	15,0	34,0	36,0	50810062480	120,00	✓
27,0	52,0	26,0	37,0	36,0	50810062680	129,00	✓
29,0	52,0	26,0	38,0	36,0	50810062780	131,00	✓
30,0	52,0	26,0	40,0	38,0	50810062980	137,00	✓
32,0	54,0	26,0	42,0	38,0	50810063080	137,00	✓
34,0	56,0	28,0	44,0	38,0	50810063280	161,00	✓
35,0	56,0	26,0	47,0	36,0	50810063480	161,00	✓
36,0	58,0	30,0	48,0	42,0	50810063580	161,00	✓
38,0	58,0	30,0	50,0	42,0	50810063680	200,00	✓
41,0	60,0	30,0	52,0	45,0	50810063880	200,00	✓
46,0	64,0	36,0	56,0	45,0	50810064180	216,00	✓
50,0	68,0	36,0	62,0	48,0	50810064680	252,00	✓
55,0	72,0	40,0	68,0	48,0	50810065080	284,00	✓
60,0	76,0	38,0	74,0	45,0	50810065580	284,00	✓
60,0	78,0	42,0	80,0	45,0	50810066080	284,00	✓

50833-4

Bits box sæt med 1/4" sekskant holder og 33 dele i plastæske.

Forkromet, krom vanadium.

Indhold:



PZ 1 / 2 (x2) / 3



PH 1 / 2 (x2) / 3



2,0 / 2,5 / 3,0 / 4,0 / 5,0 / 6,0



3,0 / 4,0 / 5,0 / 5,5 / 6,5



TX 8 / 9 / 10 / 15 (x2) / 20 (x2) / 25 (x2) / 27 / 30 / 40

Mål mm	Art. nr.	DKK	Lager
105 x 85 x 45	50833400000	248,00	✓

50834

Bits + bits skruetrækker med 31 dele i plastæske.

Forkromet, krom vanadium.

Indhold:



144 mm



PZ 0 / 1



PH 000 / 00 / 0 / 1



0,7 / 0,9 / 1,3 / 1,5 / 2,0 / 2,5 / 3,0 / 4,0



1,0 / 1,5 / 2,0 / 2,5 / 3,0 / 3,5 / 4,0



TX 4 / 5 / 6 / 7 / 8 / 9 / 10 / 15 / 20

Mål mm	Art. nr.	DKK	Lager
155 x 105 x 40	50834000000	508,00	✓

50835

Mini skruetrækker sæt med 16 dele i plastæske.

2-K skruetrækker. Ergonomisk soft grip med drejelig hætte. Klingen er lavet af krom molybdæn stål, hærdet, med sort spids.



Indhold:



PH 000 / 00 / 0



0,9 / 1,5 / 2,0 / 2,5 / 3,0



1,5 / 2,0 / 2,5



TX 4 / 5 / 6 / 7 / 8



Mål mm	Art. nr.	DKK	Lager
230 x 115 x 50	50835000000	572,00	✓













50829-3016

Topnøglesæt 1/4" med 45 dele i plastæske.

Forkromet, krom vanadium.

Indhold:



	4 / 4,5 / 5 / 5,5 / 6 / 7 / 8 / 9 / 10 / 11 / 12 / 13 / 14 mm
	150 mm (72 Tænder)
	115 mm
	150 mm
	37 mm
	50 mm
	PZ 1 / 2 / 3
	PH 1 / 2 / 3
	3 / 4 / 5 / 6
	TX 8 / 10 / 15 / 20 / 25 / 27 / 30 / 40
	4 / 5 / 6 / 7
	E 4 / 5 / 6 / 7 / 8 / 10



Mål mm	Art. nr.	DKK	Lager
320 x 140 x 55	50829301683	1.052,00	✓









50829-3019

Topnøglesæt 1/4" med 25 dele i plastæske.

Forkromet, krom vanadium.

Indhold:



	4 / 4,5 / 5 / 5,5 / 6 / 7 / 8 / 9 / 10 / 11 / 12 / 13 mm
	144 mm
	100 mm
	25 mm
	PZ 2
	PH 2
	5 / 6
	TX 10 / 15 / 20 / 25 / 30 / 40



Mål mm	Art. nr.	DKK	Lager
145 x 102 x 50	50829301983	450,00	✓

50828-3015

T-grebssæt 1/4", 29 dele i metalæske.

1/4"

Forkromet, krom vanadium.

Indhold:



115 mm



4,0 / 4,5 / 5,0 / 6,0 / 7,0 / 8,0 / 9,0 / 10,0 / 11,0 / 12,0 / 13,0 mm



100 / 250 mm



37 mm



PZ 1 / 2



3,0 / 4,0 / 5,0 / 6,0



4,0 / 5,5



TX 15 / 20 / 25 / 27 / 30 / 40

Mål mm	Art. nr.	DKK	Lager
407 x 162 x 52	50828301583	1.170,00	✓

50825-3015

Topnøglesæt 1/4" med 44 dele i plastæske.

1/4"

Forkromet, krom vanadium.

Indhold:

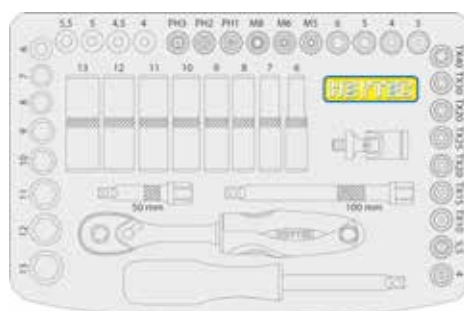

Mål mm	Art. nr.	DKK	Lager
280 x 220 x 60	50825301583	1.052,00	✓

50829-3018

Bits/topnøglesæt 1/4" med 44 dele i plastæske.



Forkromet, krom vanadium.



Indhold:

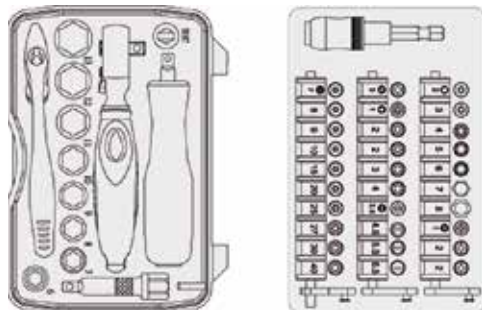

Mål mm	Art. nr.	DKK	Lager
145 x 102 x 50	50829301883	1.027,00	✓

50829-3017

Bits/topnøglesæt 1/4" med 22 dele i plastæske.



Forkromet, krom vanadium.



Indhold:

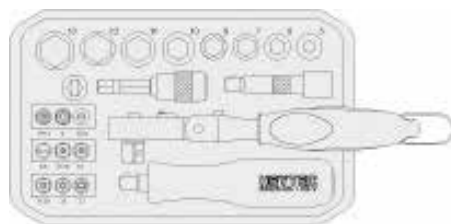

Mål mm	Art. nr.	DKK	Lager
160 x 102 x 36	50829301783	816,00	✓

50840-3015



Topnøglesæt 3/8" med 23 dele i plastæske.

Forkromet, krom vanadium.

Indhold:

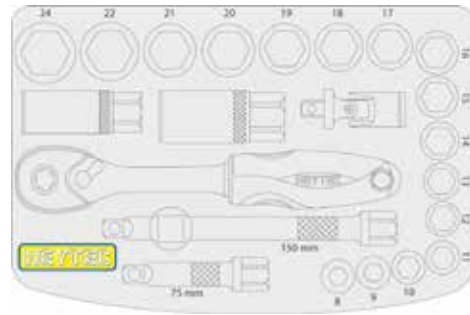

Mål mm	Art. nr.	DKK	Lager
280 x 220 x 60	50840301583	1.088,00	✓

50850-52



Topsæt 1/2" Torx ind- udvendig med 27 dele i plastæske.

Forkromet, krom vanadium.

Indhold:

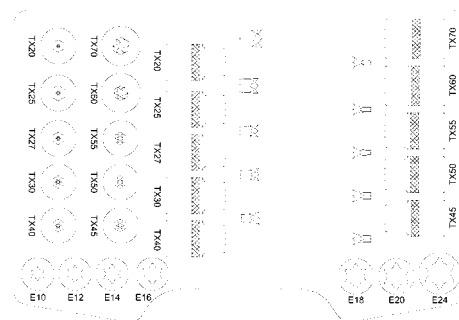

Mål mm	Art. nr.	DKK	Lager
350 x 280 x 80	50850520083	1.620,00	✓

50850-53



Topsæt 1/2" Torx, torx m/ hul, sekskant, XZN med 33 dele i plastæske.

Forkromet, krom vanadium.

Indhold:

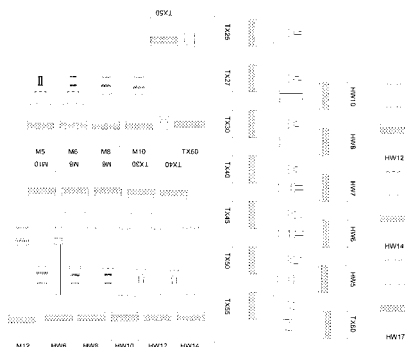

Mål mm	Art. nr.	DKK	Lager
350 x 280 x 80	50850530083	1.604,00	✓



50850-54



Topsæt 1/2" XZN + RIBE med 28 dele i plastæske.



Forkromet, krom vanadium.

Indhold:

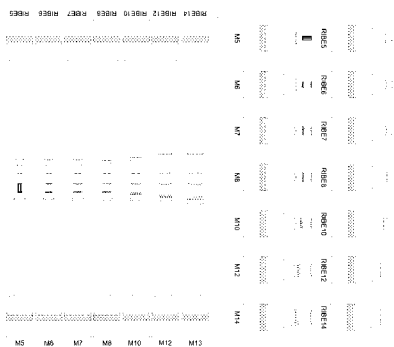

Mål mm	Art. nr.	DKK	Lager
350 x 280 x 80	50850540083	1.604,00	✓

50850-55



Topsæt 1/2" sekskantsæt med 20 dele i plastæske.



Forkromet, krom vanadium.

Indhold:

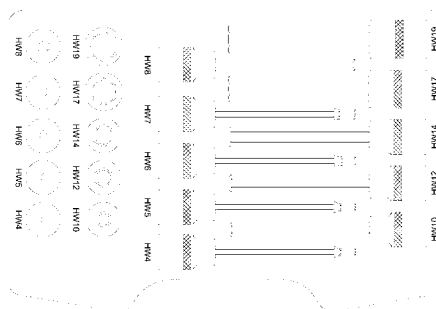

Mål mm	Art. nr.	DKK	Lager
350 x 280 x 80	50850551283	1.537,00	✓

50850-56



Topsæt 1/2" sekskantsæt med 7 dele i metalæske.



Forkromet, krom vanadium.

Indhold:

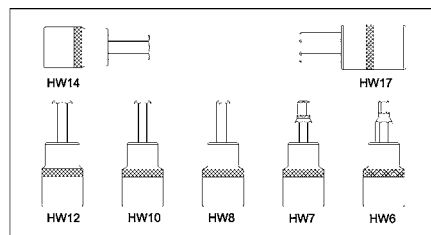

Mål mm	Art. nr.	DKK	Lager
250 x 135 x 40	50850560283	716,00	✓



50850-59



Topsæt 1/2" Torx med hul med 9 dele i metalæske.

Forkromet, krom vanadium.

Indhold:

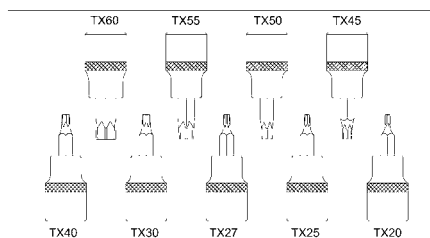

1/2"

Mål mm	Art. nr.	DKK	Lager
250 x 135 x 40	50850590083	785,00	✓

50855-3015



Topnøglesæt 1/2" med gennemgående hul med 14 dele i metalæske.

Forkromet, krom vanadium.

Indhold:

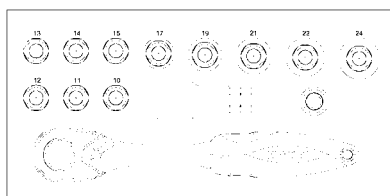

1/2"

Mål mm	Art. nr.	DKK	Lager
320 x 160 x 55	50855301583	1.358,00	✓

50851-3015



Topnøglesæt 1/2" med 18 dele i plastæske.

Forkromet, krom vanadium.

Indhold:

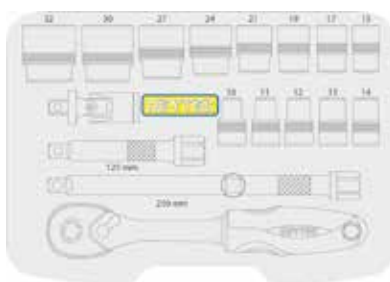

1/2"

Mål mm	Art. nr.	DKK	Lager
350 x 280 x 80	50851301583	1.227,00	✓

50825-5015**1/2"****1/4"**

Topnøglesæt 1/2" + 1/4" med gennemgående hul med 105 dele i plastæske.

Forkromet, krom vanadium.

Indhold:



Mål mm	Art. nr.	DKK	Lager
350 x 280 x 80	50825501583	2.590,00	✓

508101-310**3/4"**

Topnøglesæt 3/4" med 21 dele i plastæske.

Forkromet, krom vanadium.

Indhold:

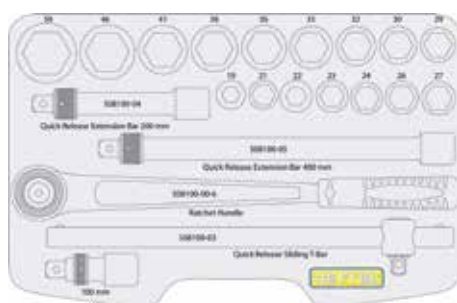

Mål mm	Art. nr.	DKK	Lager
580 x 400 x 90	50810131080	4.383,00	✓

5081129 / 5081129-28

Værkstedsvogn med 100 dele værktøj (se foto) eller tom.

5 stk. skuffer, 2 stk. hjulbremser samt central cylinderlås.



Art. nr.. M 50829-13



Art. nr.. M 50829-12



Art. nr.. M 50829-14



Art. nr.. M 50829-4



Art. nr.. M 50829-5



Art. nr.. M 50829-15



Art. nr.. M 50829-8



Art. nr.. M 50829-16

	Mål L x B x H	Art. nr.	DKK	Lager
Værkstedsvogn (uden værktøj)	600 x 440 x 950	50811290120	6.082,00	✓
Værkstedsvogn m. 100 dele	600 x 440 x 950	50811292800	10.603,00	✓

508675

Værktøjskuffert 134 dele.



Dele	Mål L x B x H	Art. nr.	DKK	Lager
Værktøjskuffert 134 dele	460 x 370 x 170	50867500000	7.743,00	✓

508076-945

Værktøjskasse med 96 dele værktøj, bestående af 5 moduler (se foto).

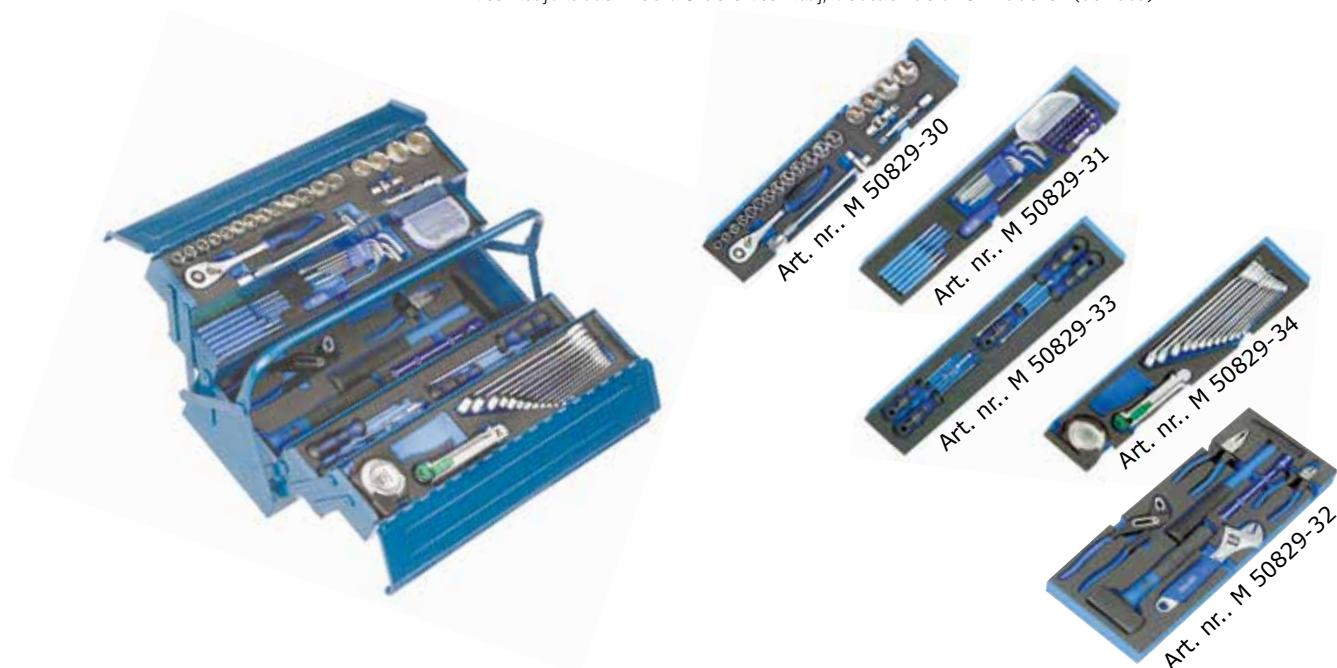

Mål mm	Art. nr.	DKK	Lager
530 x 200 x 200	50807694500	4.575,00	✓

50820176200

Værktøjskuffert 97 dele, bestående af 2 moduler (se foto).



Dele	Mål L x B x H	Vægt Kg.	Art. nr.	DKK	Lager
97 dele	442 x 357 x 151	11,690	50820176200	6.332,00	✓

Heyco værktøjskuffert 77 dele, bestående af 2 moduler (se foto).



Dele	Mål L x B x H	Vægt Kg.	Art. nr.	DKK	Lager
77 dele	442 x 357 x 151	9,610	200678082	8.611,00	✓

80879/880/882/885/886

Momentnøgler.

Indhold: 1 stk.



Størrelse "	Nm	Længde mm	Art. nr.	DKK	Lager
1/4	3 - 15	190 - 210	50879000080	1.180,00	✓
1/4	4 - 20	300 - 320	50880000080	1.292,00	✓
3/8	20 - 120	405 - 435	50882000080	1.552,00	✓
1/2	40 - 200	485 - 510	50885000080	1.602,00	✓
3/4	100 - 600	1.035 - 1.052	50886000080	6.517,00	✓

Momentskruetrækker 1/4" 10-120 cNm.



Indhold: 1 stk.



Længde mm	Art. nr.	DKK	Lager
160 - 180	50878000080	1.191,00	✓

Heyco momentnøgler.

Indhold: 1 stk.



Størrelse "	Nm	Længde mm	Vægt kg	Art. nr.	DKK	Lager
1/4	5 - 25	275	0,520	751000080	3.166,00	✓
3/8	10 - 60	355	0,759	752000080	3.235,00	✓
1/2	60 - 320	621	1,740	756000080	3.804,00	✓
3/4	300 - 850	1.270	6,600	757000080	15.920,00	✓

5086300-B / 5086300-4



Hjul top 1/2" med plast og magnet eller som sæt med 4 stk.



 MM	L mm	Art. nr.	DKK	Lager
17	85	50863001730	220,00	✓
19	85	50863001930	220,00	✓
21	85	50863002130	220,00	✓
22	85	50863002230	220,00	✓
17 - 19 - 21 - 22	85	50863000430	1.048,00	✓

5086300-19-B



Hjul top 1/2" med plast og magnet - lang udgave.



	L mm	Art. nr.	DKK	Lager
17	150	50863191730	388,00	✓
19	150	50863191930	388,00	✓

5086300 / 5086300-3

Hjul top 1/2" med plast eller som sæt med 3 stk.



 MM	L mm	Art. nr.	DKK	Lager
17	85	50863001760	87,00	✓
19	85	50863001960	87,00	✓
21	85	50863002160	87,00	✓
17 - 19 - 21	85	50863000300	278,00	✓

5086300-B / 5086300-19-3

Hjul toppesæt 1/2" med plast-lang udg. eller som sæt med 3 stk.



 MM	L mm	Art. nr.	DKK	Lager
17	150	50863191760	185,00	✓
19	150	50863191960	185,00	✓
21	150	50863192160	185,00	✓
17 - 19 - 21	150	50863190300	635,00	✓

5081835

Torpedo vaterpas.
Lavet af 2-komponent plast samt aluminium, magnetiske, lodret libelle, vandret libelle og libelle til 45 ° måling.

L mm	Art. nr.	DKK	Lager
230	50818350000	80,00	✓

5081669

Kniv med 2-komponent plasthåndtag.

L mm	Art. nr.	DKK	Lager
170	50816690000	76,00	✓

5081680

Filesæt, 5 dele, 8".



L mm	Art. nr.	DKK	Lager
200	50816800500	421,00	✓

50830

Splituddriver sæt, 6 dele.

L mm	Ø mm	Art. nr.	DKK	Lager
150	3 - 4 - 5 - 6 - 7 - 8	50830000000	255,00	✓

5081490

Gevindskæresæt HSS, 16 dele.

Forkromet, krom vanadium.

Indhold:

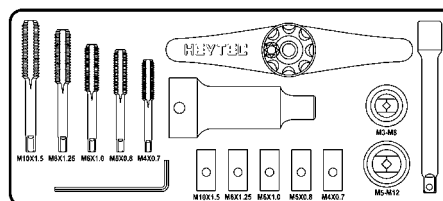

Mål mm	Art. nr.	DKK	Lager
220 x 110 x 45	50814900000	1.142,00	✓

50846-33

Skruetrækgersæt VDE, 18 dele.

Forkromet, krom vanadium.

Indhold:



150-250 V



115 mm



PZ 1 x 100 / 2 x 100



5 mm / 7 - 8 mm



PH 1 x 100 / 2 x 100



9 mm



4,0 / 5,5



3 - 5 mm



TX 10 x 100 / 15 x 100 / 20 x 100

Mål mm	Art. nr.	DKK	Lager
220 x 130 x 70	50846000033	681,00	✓

5080542-9

T-nøglesæt, sekskant, 9 dele.



Størrelse mm	Art. nr.	DKK	Lager
5,5 / 6 / 7 / 8 / 9 / 10 / 11 / 12 / 13	50805429080	796,00	✓

5081338-8 / 5081347-8



T-nøgler med tværgreb i alt 8 dele eller Torxsæt med tværgreb i alt 9 dele.





 MM eller 	Art. nr.	DKK	Lager
2 / 2,5 / 3 / 4 / 5 / 6 / 8 / 10	50813380080	450,00	✓
T 10 / T 15 / T 20 / T 25 / T 27 / T 30 T 40 / T 45 / T 50	50813470080	565,00	✓

H 5081340-7 / H 5081348-7



Sekskantsæt eller Torxsæt foldehåndtag.



 MM eller 	Art. nr.	DKK	Lager
1,5 / 2 / 2,5 / 3 / 4 / 5 / 6	50813406280	99,00	✓
T 10 / T 15 / T 20 / T 25 / T 27 / T 30 T 40	50813486280	127,00	✓

5081267



Kabelsko sortiment.
Modul med 249 dele.

Dele	Art. nr.	DKK	Lager
249	50812670000	716,00	✓

HP 5081343-9 / HP 5081348-9

Vinkeløglesæt, Sekskant eller Torx, 9 dele.



 <u>MM</u> eller 	Art. nr.	DKK	Lager
1,5 / 2 / 2,5 / 3 / 4 / 5 / 6 / 8 / 10	50813438280	143,00	✓
T 10 / T 15 / T 20 / T 25 / T 27 / T 30 T 40 / T 45 / T 50	50813488280	179,00	✓

HP 5081344-9 / HP 5081349-9**Lang udgave**

Vinkeløglesæt lang, Sekskant eller Torx, 9 dele.



 <u>MM</u> eller 	Art. nr.	DKK	Lager
1,5 / 2 / 2,5 / 3 / 4 / 5 / 6 / 8 / 10	50813448280	174,00	✓
T 10 / T 15 / T 20 / T 25 / T 27 / T 30 T 40 / T 45 / T 50	50813498280	202,00	✓

5081500

Dækjern til alufælge med plastbeskytter.

Længde mm	Art. nr.	DKK	Lager
380	50815003880	381,00	✓
500	50815005080	566,00	✓

50801329

Oliefilternøgle til 3/8" og 1/2" firkant, SW22.

Ø mm	Art. nr.	DKK	Lager
65 -120	50801329080	220,00	✓

Rørskærer.



50816402500



50816403200



50816436700



50816431500

Længde mm		Art. nr.	DKK	Lager
80	3 - 25 mm	50816402500	137,00	✓
135	3 - 32 mm	50816403200	247,00	✓
65	15 mm	50816431500	151,00	✓

5081646-42



Rørsaks.

Bruges til at klippe PVC, gummi rør og plastik rør over med optil Ø 42 mm.

Længde mm	Ø mm	Art. nr.	DKK	Lager
210	42	50816464200	408,00	✓

5081500



Nedstryger.

Med klik anordning, 300 mm/12 " klinge længde, profi-kvalitet med 2-komponent / ergonomisk håndtag, Savklingen er justerbar og kan låses i forskellige vinkler 10 stk. savklinger med i sættet.

Længde mm	Art. nr.	DKK	Lager
300	50816100000	260,00	✓

5081610



Junior Sav.

Med klik anordning, 150 mm/6 " klinge længde, profi-kvalitet med 2-komponent / ergonomisk håndtag, Savklingen er justerbar og kan låses i forskellige vinkler 10 stk. savklinger med i sættet.

Længde mm	Art. nr.	DKK	Lager
150	50816120000	119,00	✓



Fugepistol Multi Power.

Bruges med poser (600 ml).

Mål mm	Art. nr.	DKK	Lager
490 x 255 x 65	50817910300	467,00	✓



Fugepistol Compact med bæltespænde.

Mål mm	Art. nr.	DKK	Lager
340 x 205 x 65	50817910000	415,00	✓



Kvalitets digital skydelærer 150 mm.

Mål område	Opløsning mm	Nøjagtighed mm	Art. nr.	DKK	Lager
0-150 mm	0,01	+ - 0,03	1807015080	500,00	✓

